

І. У. ЖЫТКО

Мае
першыя
ўрокі

МАТЭМАТЫЧНЫ КАЛЕЙДАСКОП

РАБОЧЫ СШЫТАК

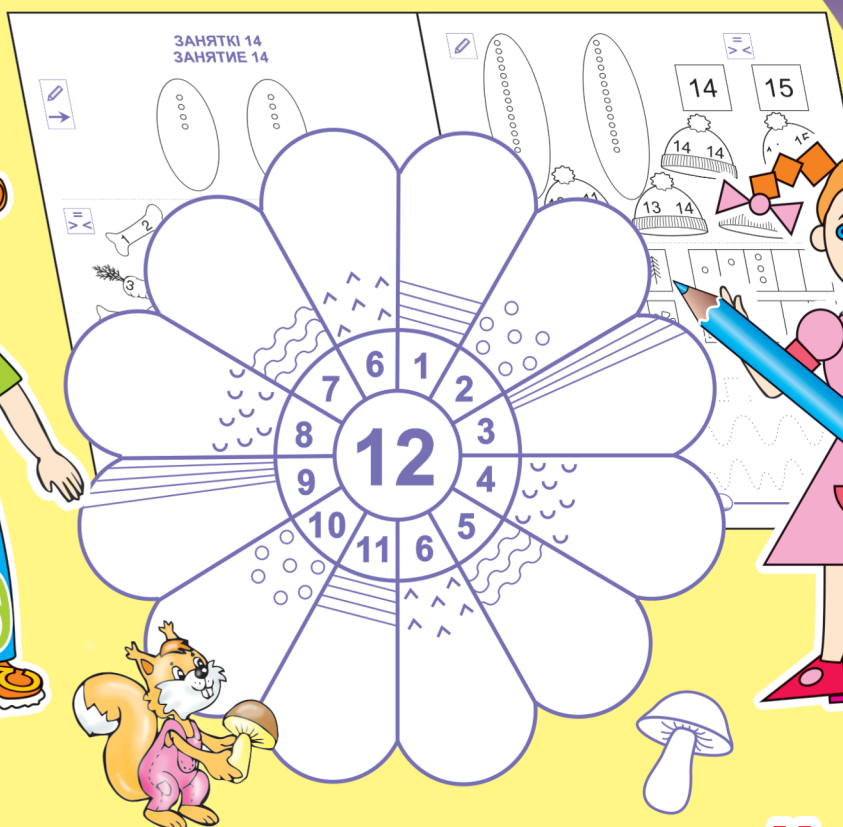

МАТЕМАТИЧЕСКИЙ КАЛЕЙДОСКОП

РАБОЧАЯ ТЕТРАДЬ

Мае
першыя
ўрокі

І. У. Жытко

МАТЭМАТЫЧНЫ КАЛЕЙДАСКОП

РАБОЧЫ СШЫТАК

МАТЕМАТИЧЕСКИЙ КАЛЕЙДОСКОП

РАБОЧАЯ ТЕТРАДЬ

Вучэбны дапаможнік
для выхаванцаў старшых груп
(ад 5 да 7 гадоў) устаноў
дашкольнай адукацыі з беларускай
і рускай мовамі навучання

*Дарушчана
Міністэрствам адукацыі
Рэспублікі Беларусь*

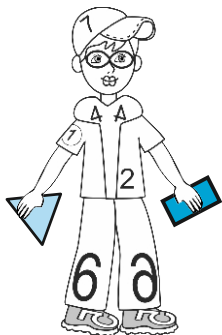

Мінск



Нацыянальны інстытут адукацыі

2020

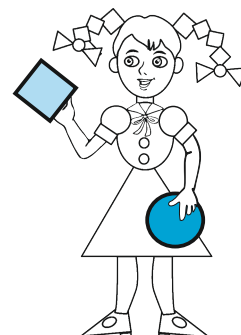

УДК 373.2.016:511-028.31
ББК 74.102
Ж94

Р э ц е н з е н т ы:

лабараторыя дашкольнай адукацыі Навукова-метадычнай установы
«Нацыянальны інстытут адукацыі» Міністэрства адукацыі Рэспублікі Беларусь
(загадчык лабараторыі кандыдат педагогічных навук *Р. Р. Касянюк*);
выхавацель вышэйшай кваліфікацыйнай катэгорыі дзяржаўнай установы адукацыі
«Санаторны яслі-сад № 367 г. Мінска» *І. К. Свірыдовіч*

ISBN 978-985-594-529-2

© Жытко І. У., 2020
© Афармленне. НМУ «Нацыянальны
інстытут адукацыі», 2020

ЗАДАННІ АБАЗНАЧАНЫ ПІКТАГРАМАМІ

ЗАДАНИЯ ОБОЗНАЧЕНЫ ПИКТОГРАММАМИ

адкажы на пытанне



ответь на вопрос

намалюй, дамалюй,
заштрыхуй



нарисуй, дорисуй,
заштрихуй

размалюй



раскрась

злучы стрэлкай,
лініяй

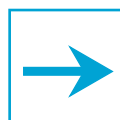

соедини стрелкой,
линией

абвядзі



обведи

раскажы, скажы



расскажи, скажи

выберы і намалюй
патрэбны знак



выбери и нарисуй
нужный знак

злучы кропкі,
малюй па кропках



соедини точки,
рисуй по точкам

ЗАНЯТКИ 1

ЗАНЯТИЕ 1

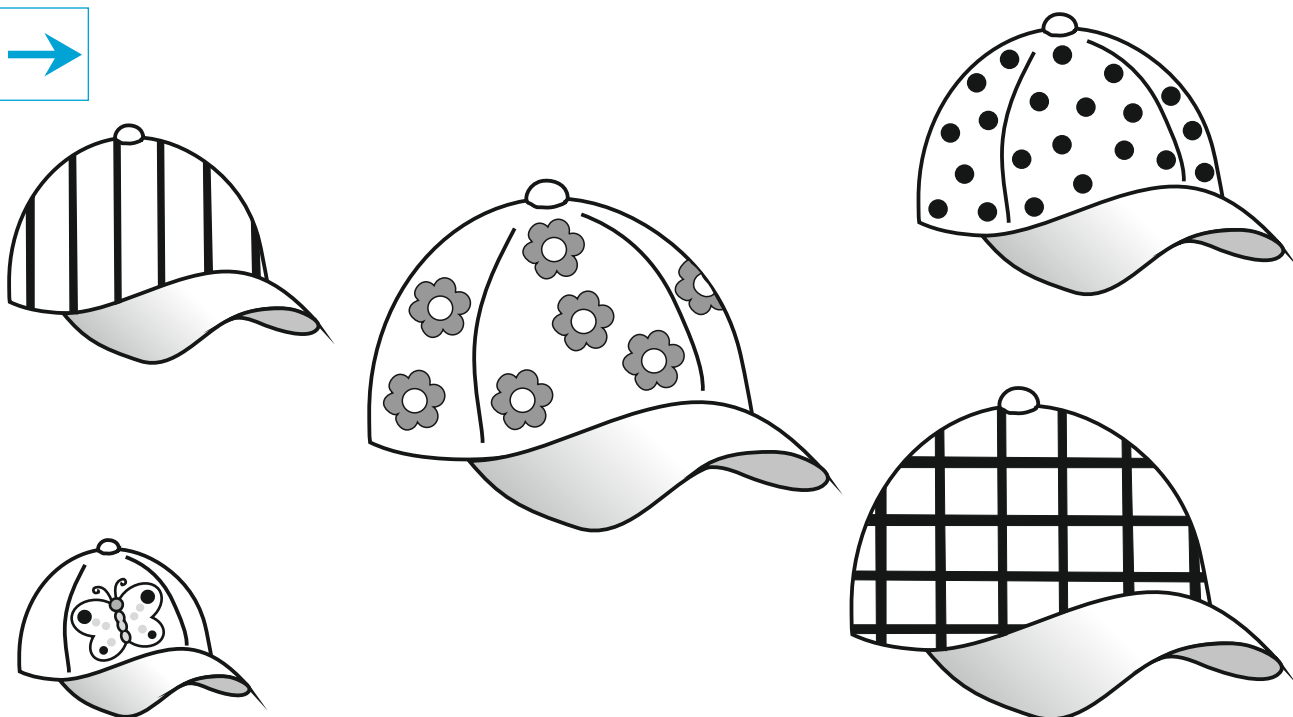
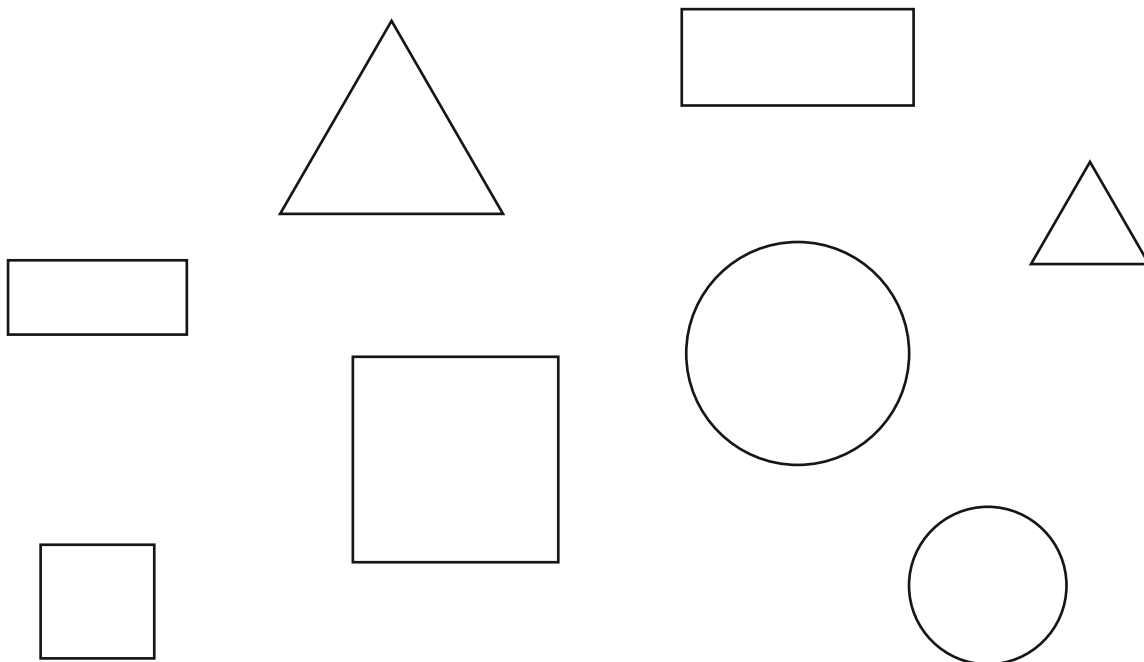

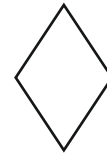
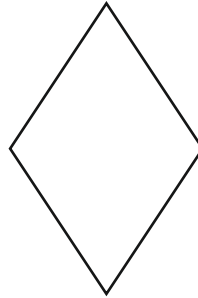
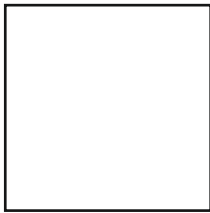
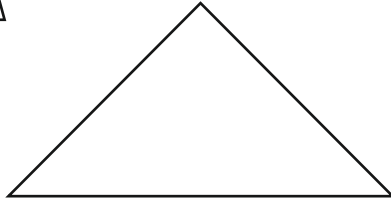
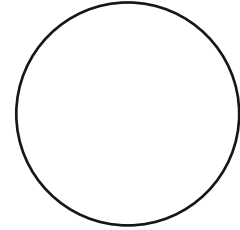
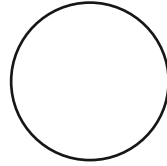
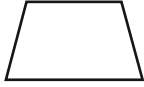
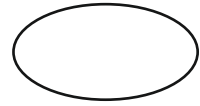
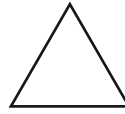
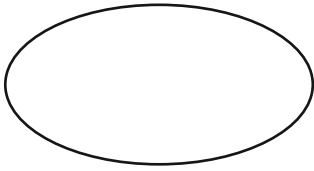

1

4

9

3

6

10

5

8

2

7



5

ЗАНЯТКИ 2

ЗАНЯТИЕ 2

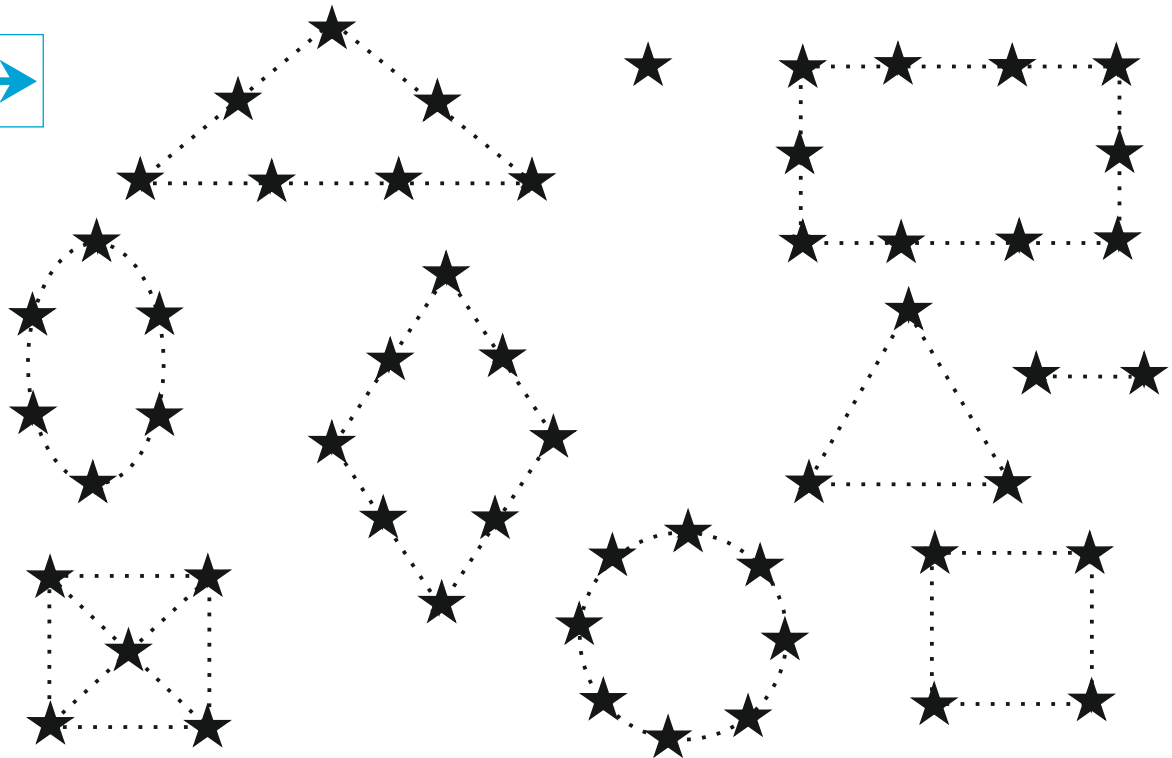
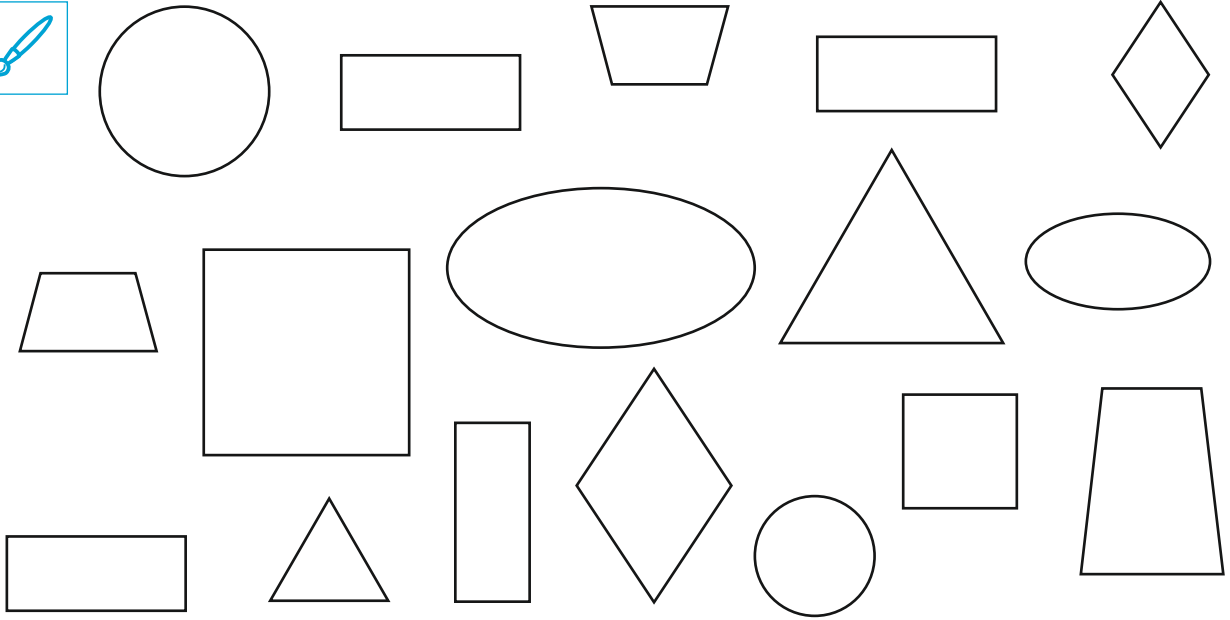

- 1
- 2
- 3
- 4
- 5
- 6
- 7
- 8
- 9
- 10

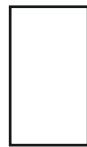
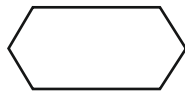
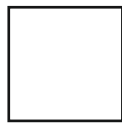
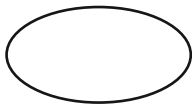
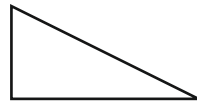
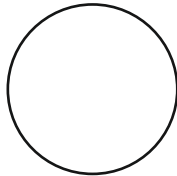
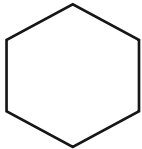
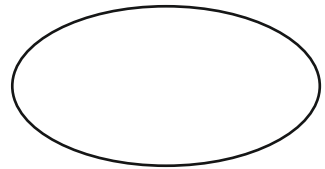
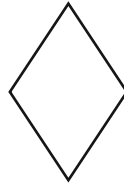
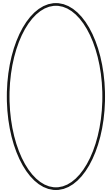
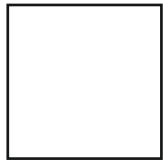
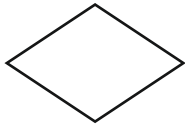
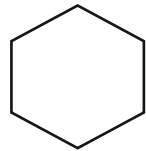
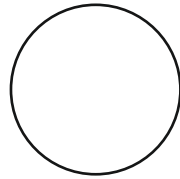
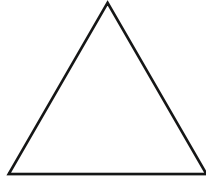



ЗАНЯТКИ 3

ЗАНЯТИЕ 3

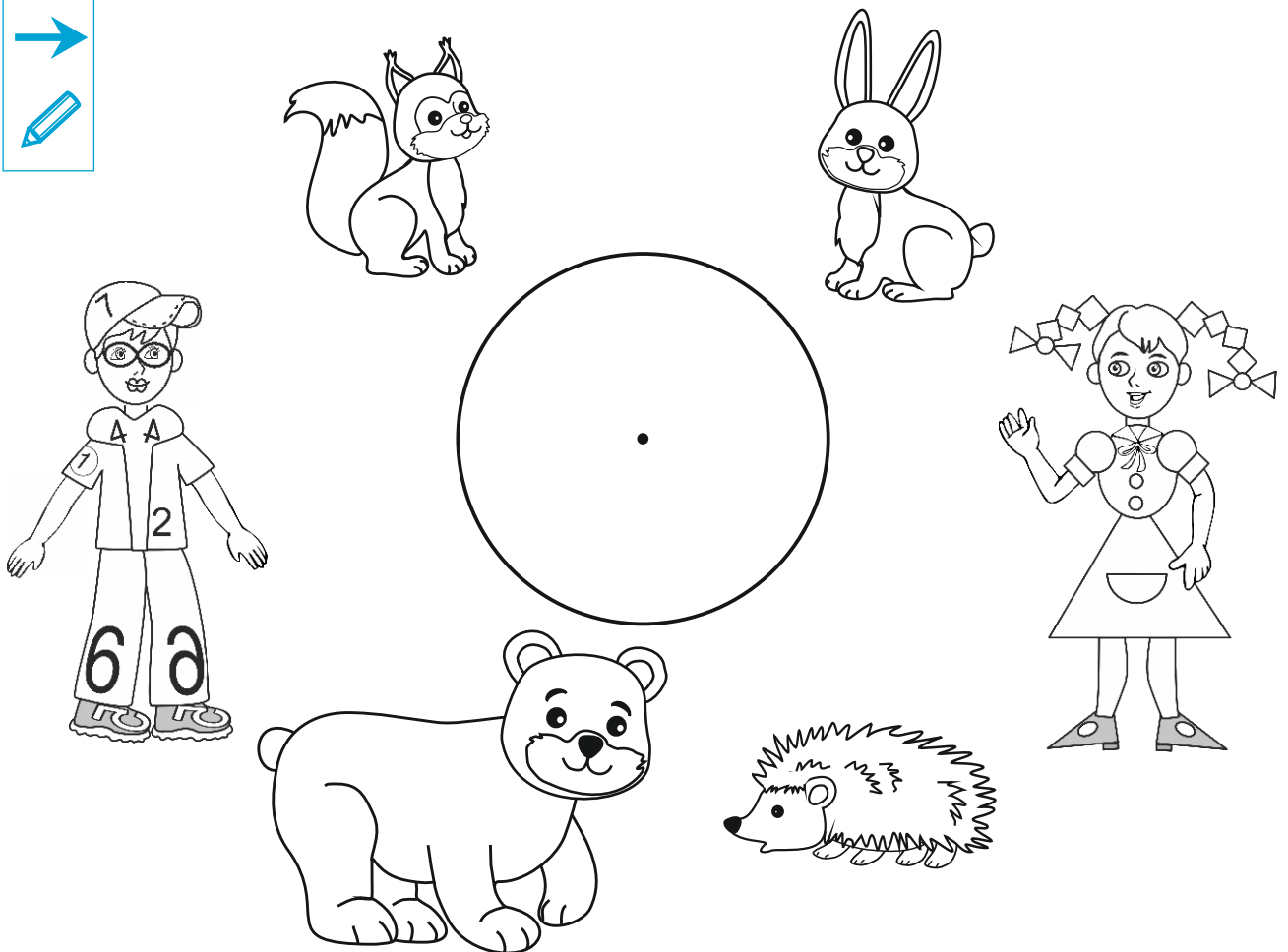
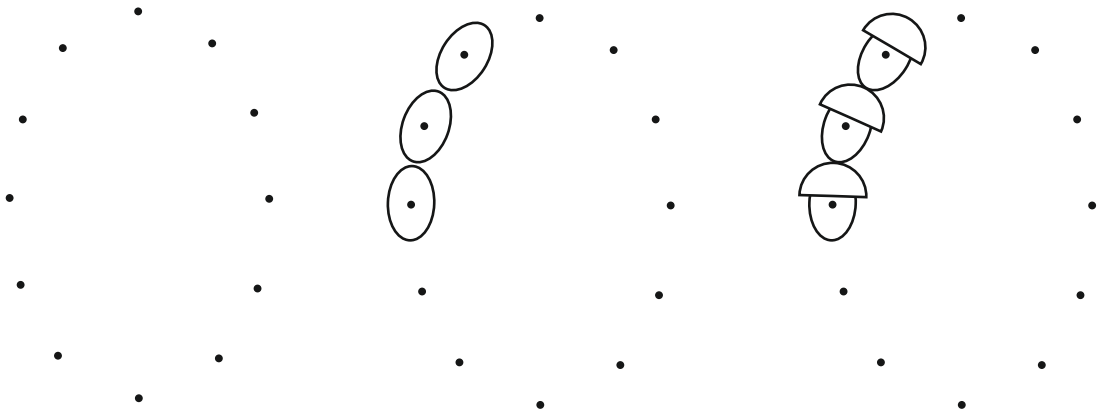

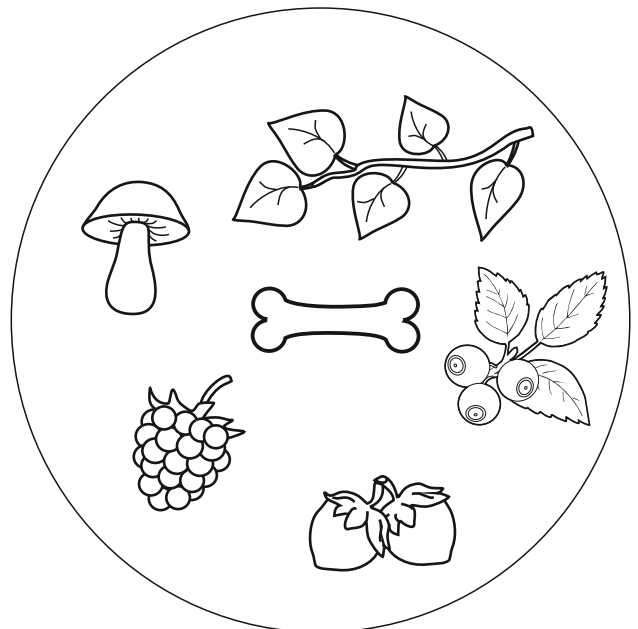
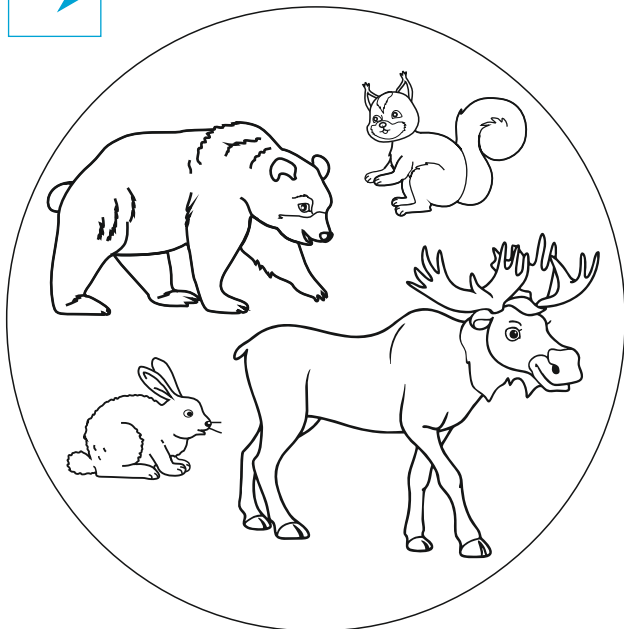
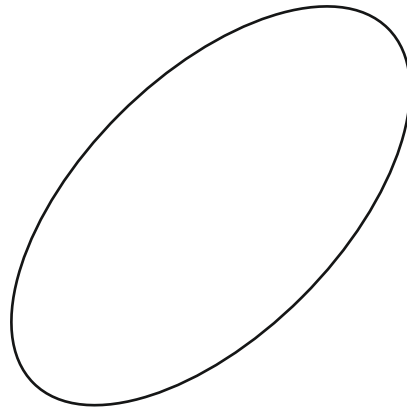
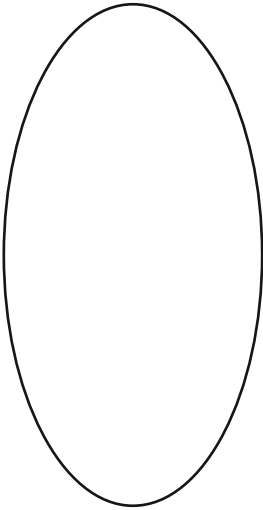
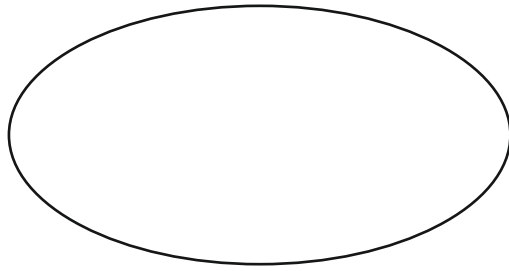

ЗАНЯТКИ 4

ЗАНЯТИЕ 4

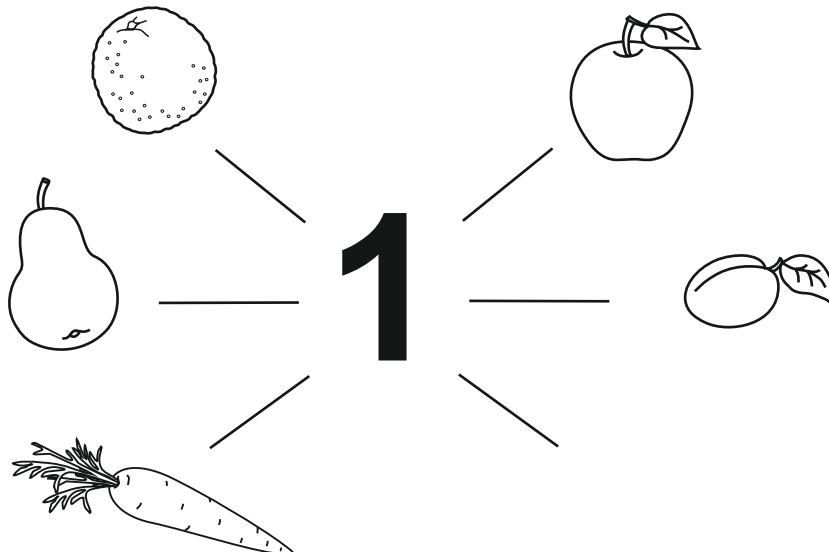
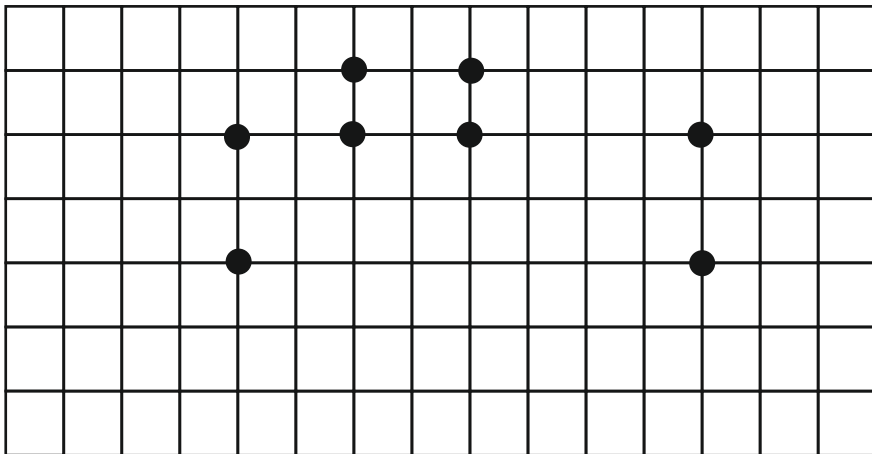
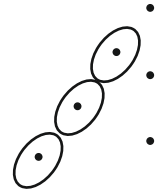
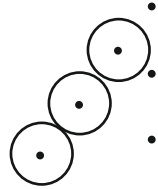

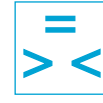
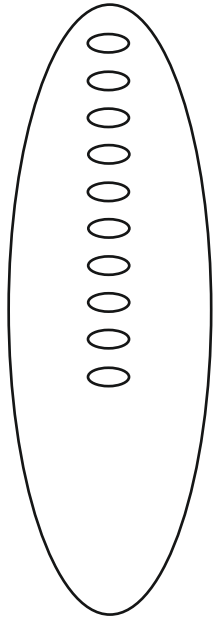
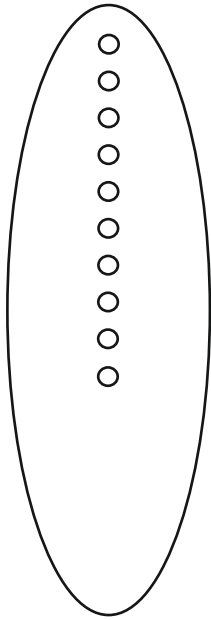

10

11

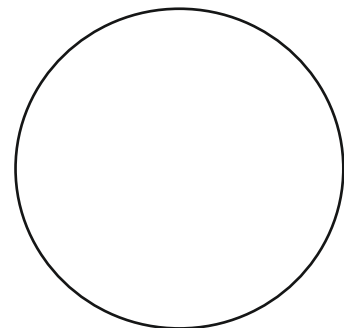
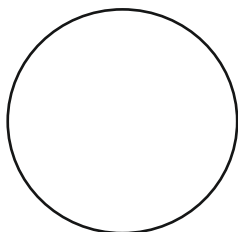
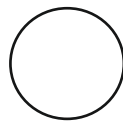
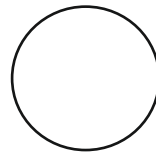
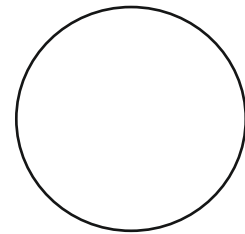
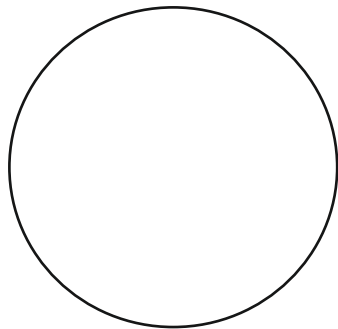
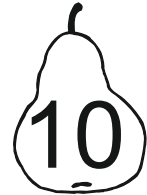
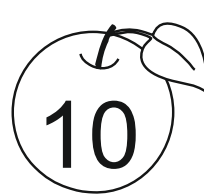

ЗАНЯТКИ 5 ЗАНЯТИЕ 5

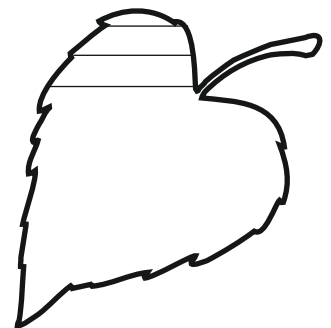
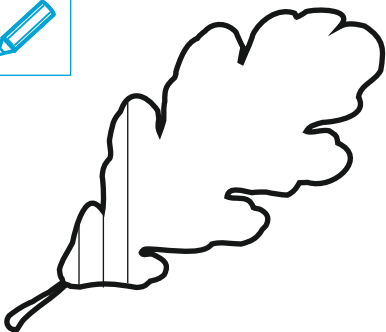
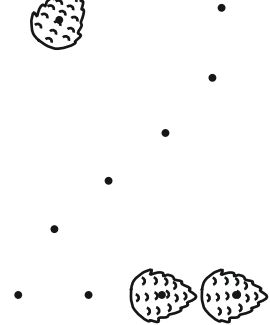
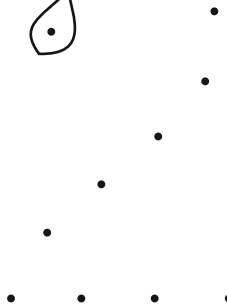
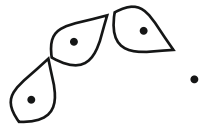
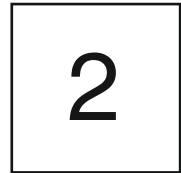
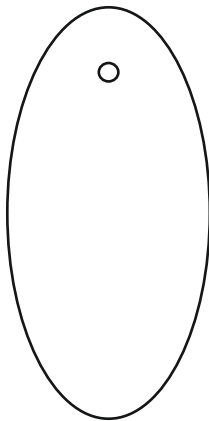
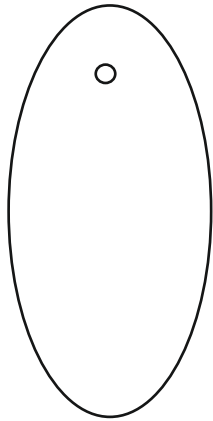

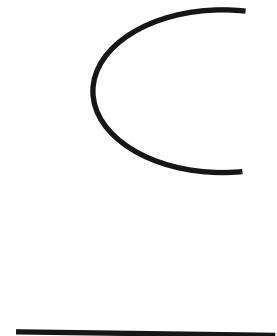
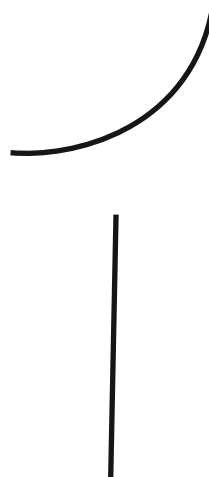
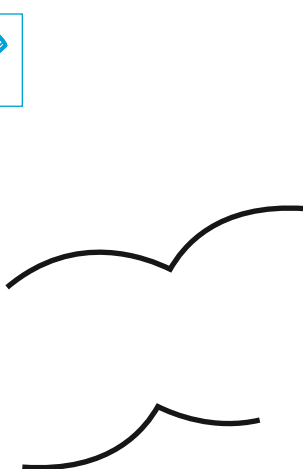
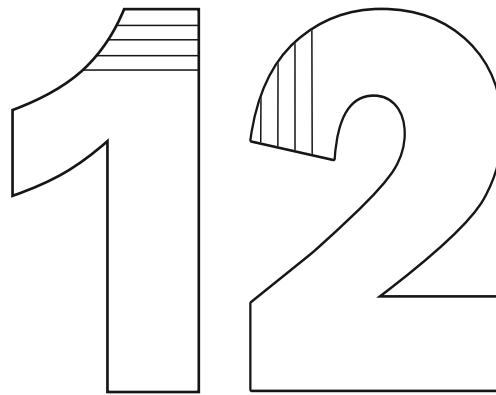
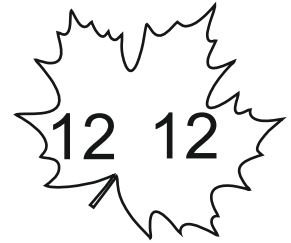
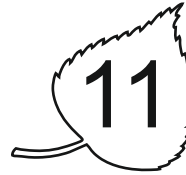
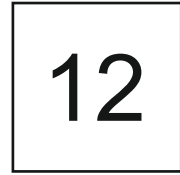
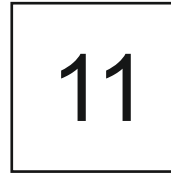
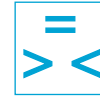
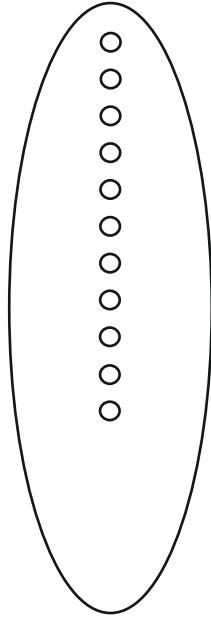
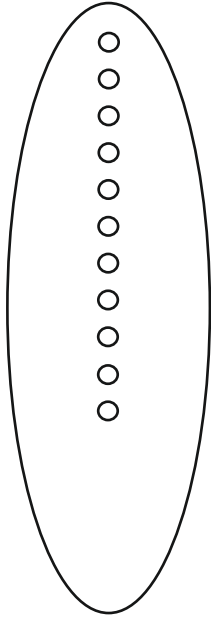

ЗАНЯТКИ 6

ЗАНЯТИЕ 6

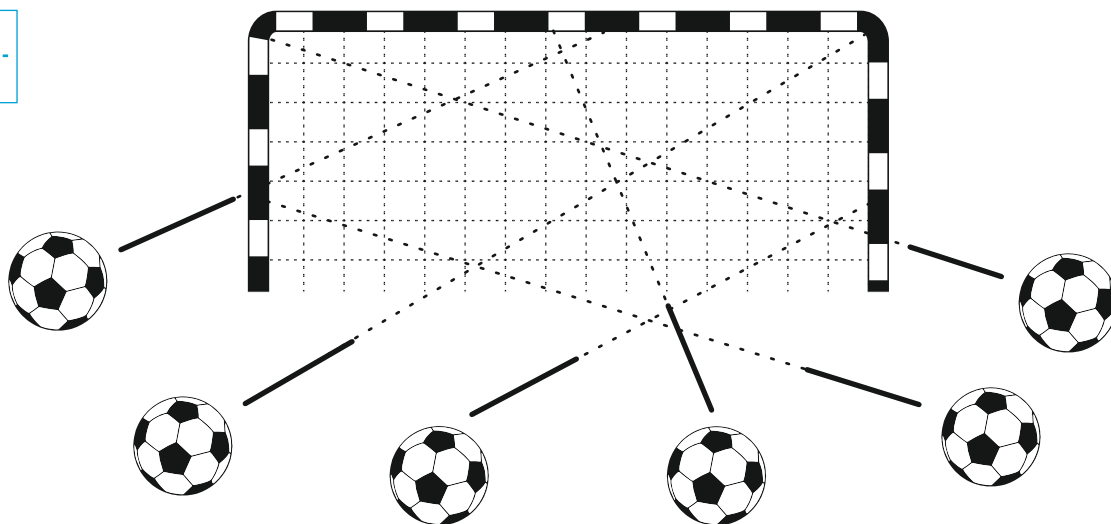
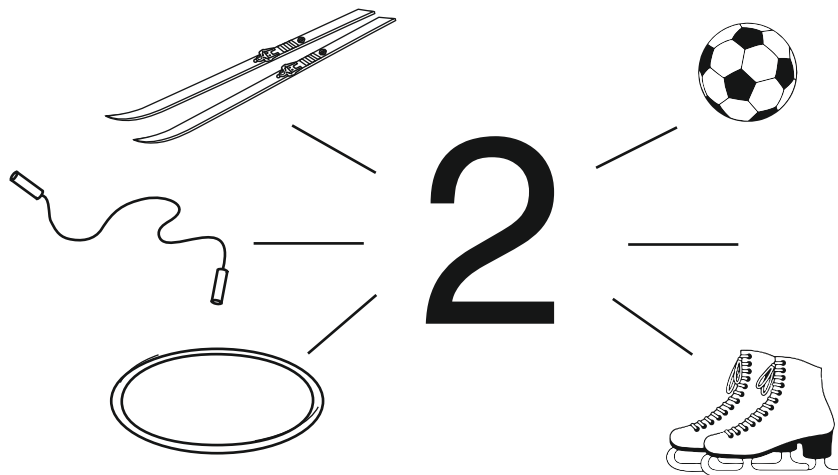
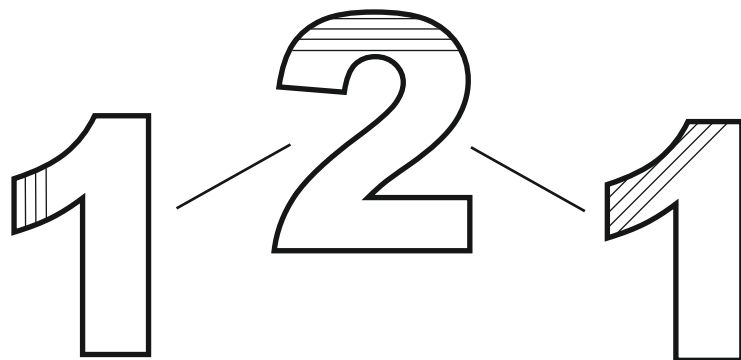

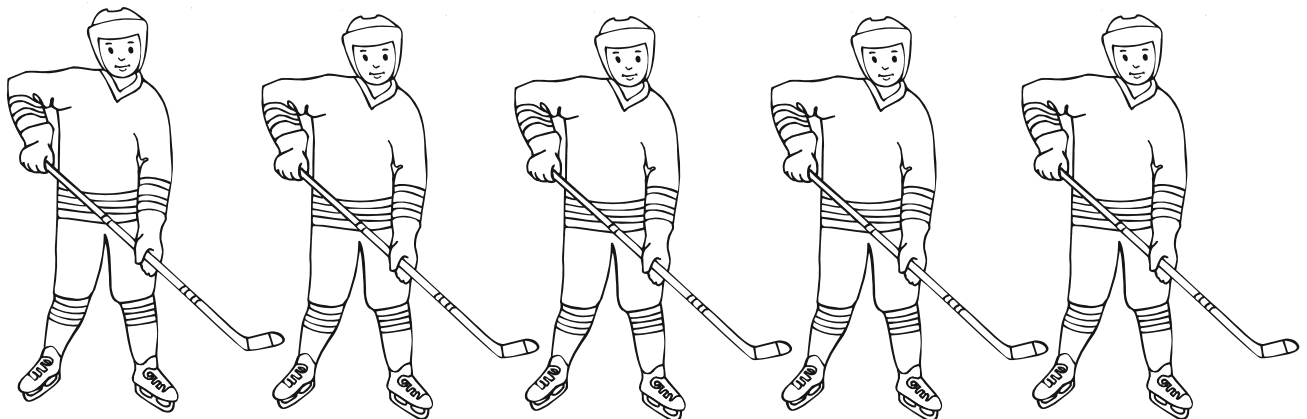
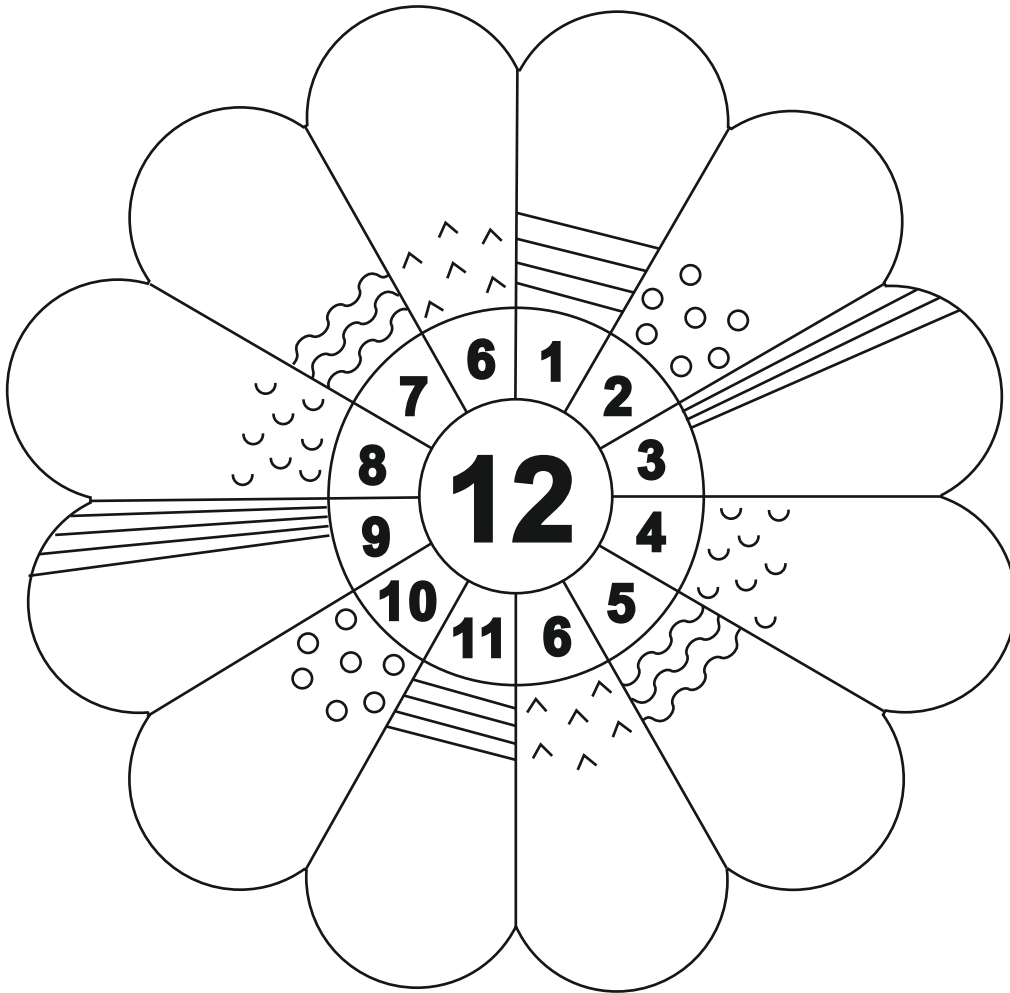

ЗАНЯТКИ 7 ЗАНЯТИЕ 7

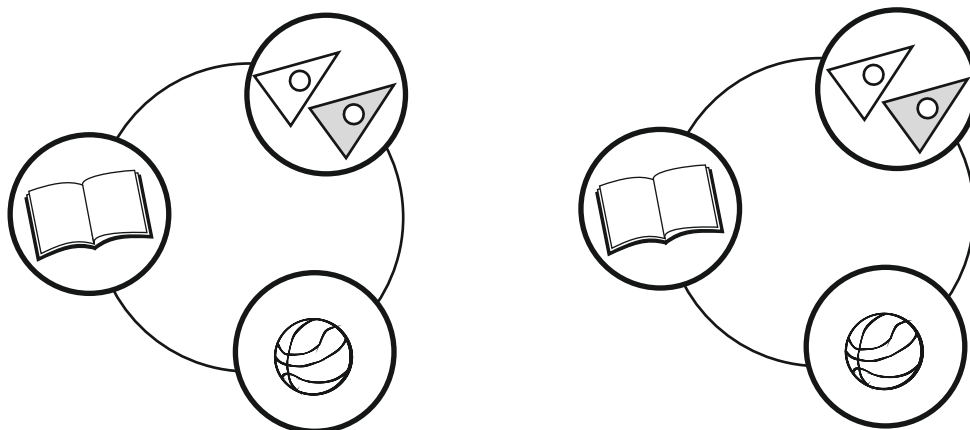
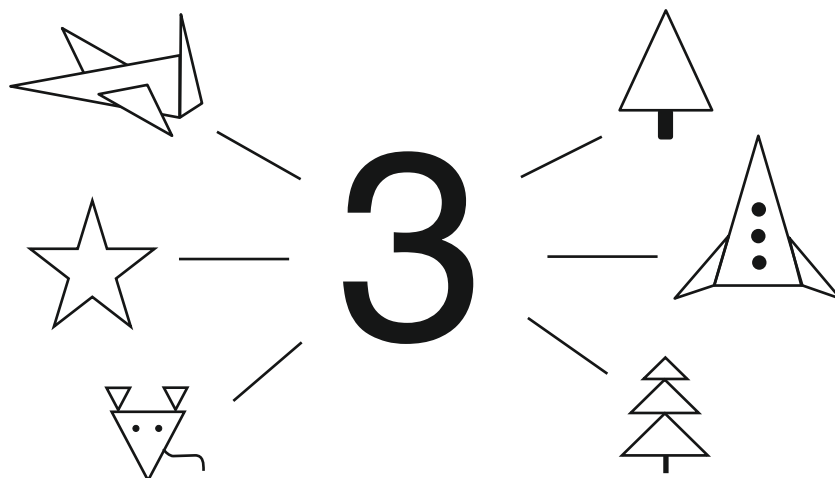
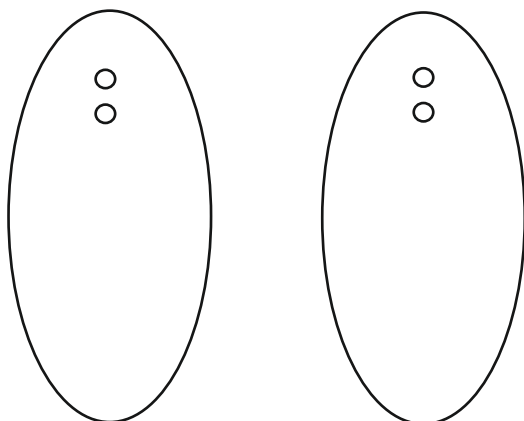

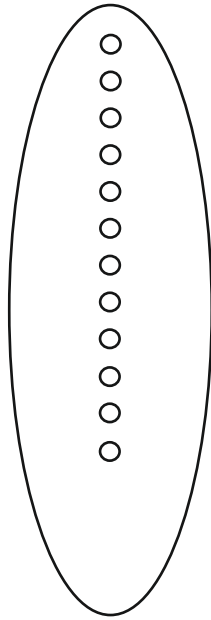
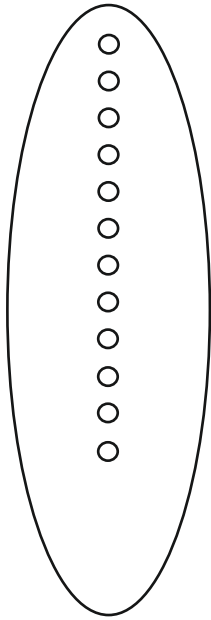

12

13

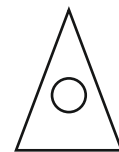
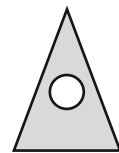
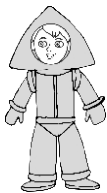
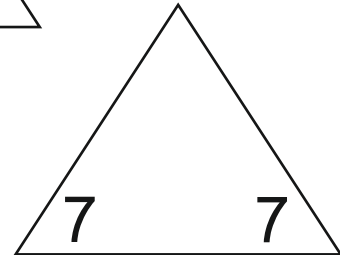
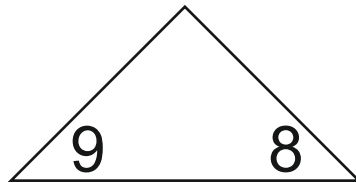
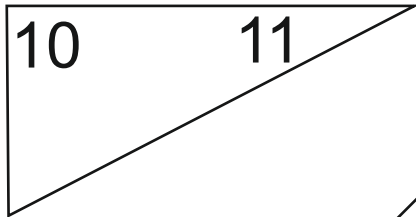
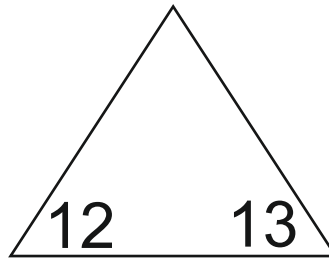
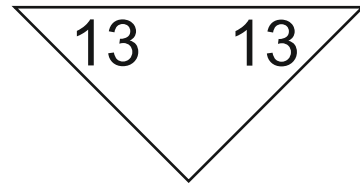

ЗАНЯТКИ 8

ЗАНЯТИЕ 8

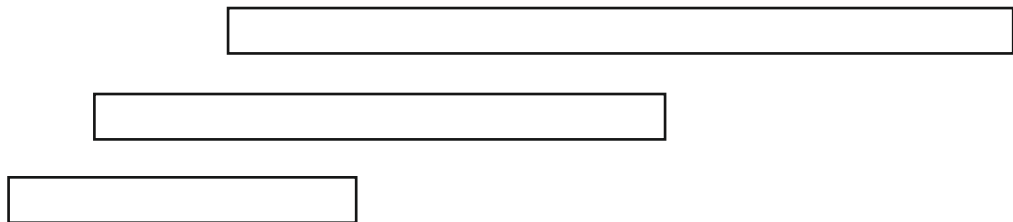
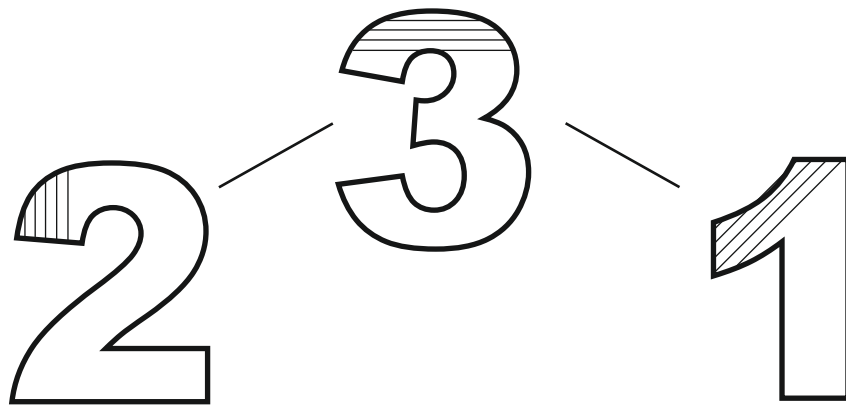
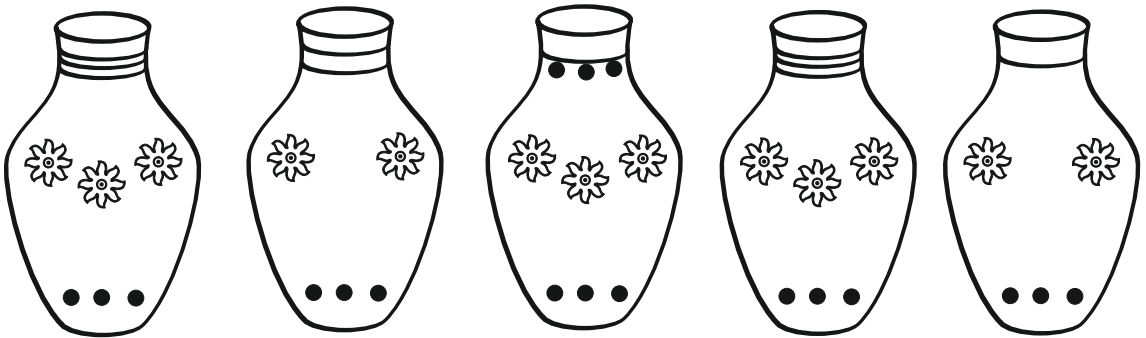
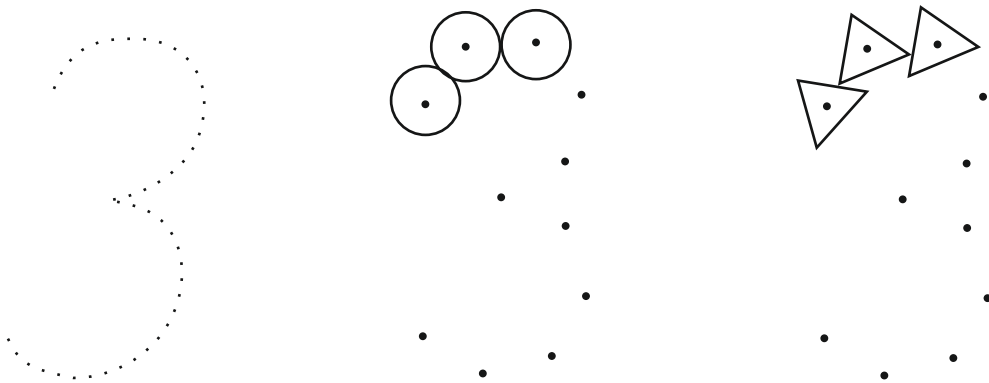

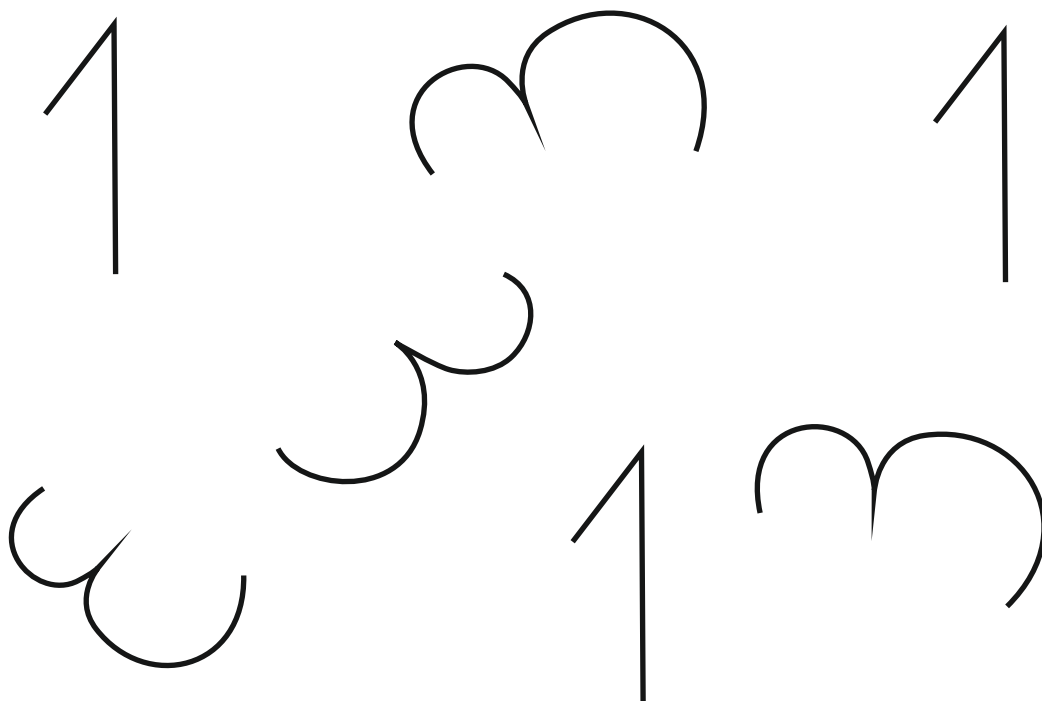
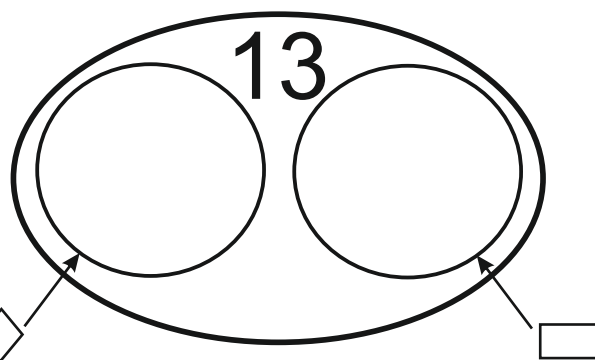
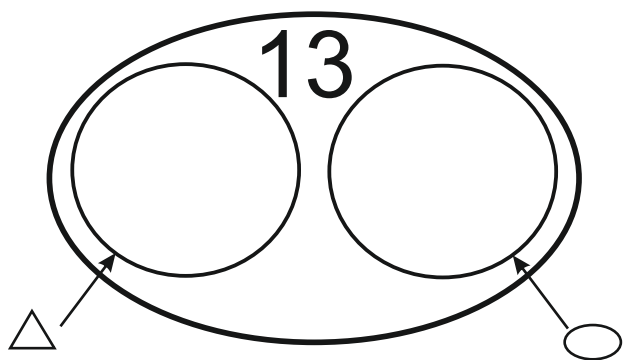
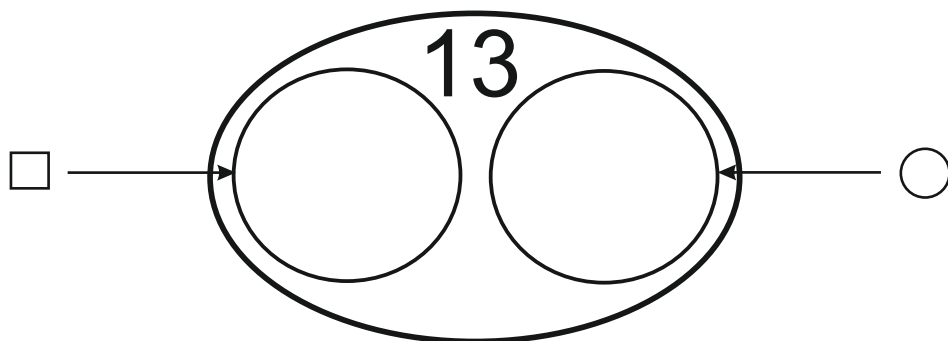

ЗАНЯТКИ 9

ЗАНЯТИЕ 9

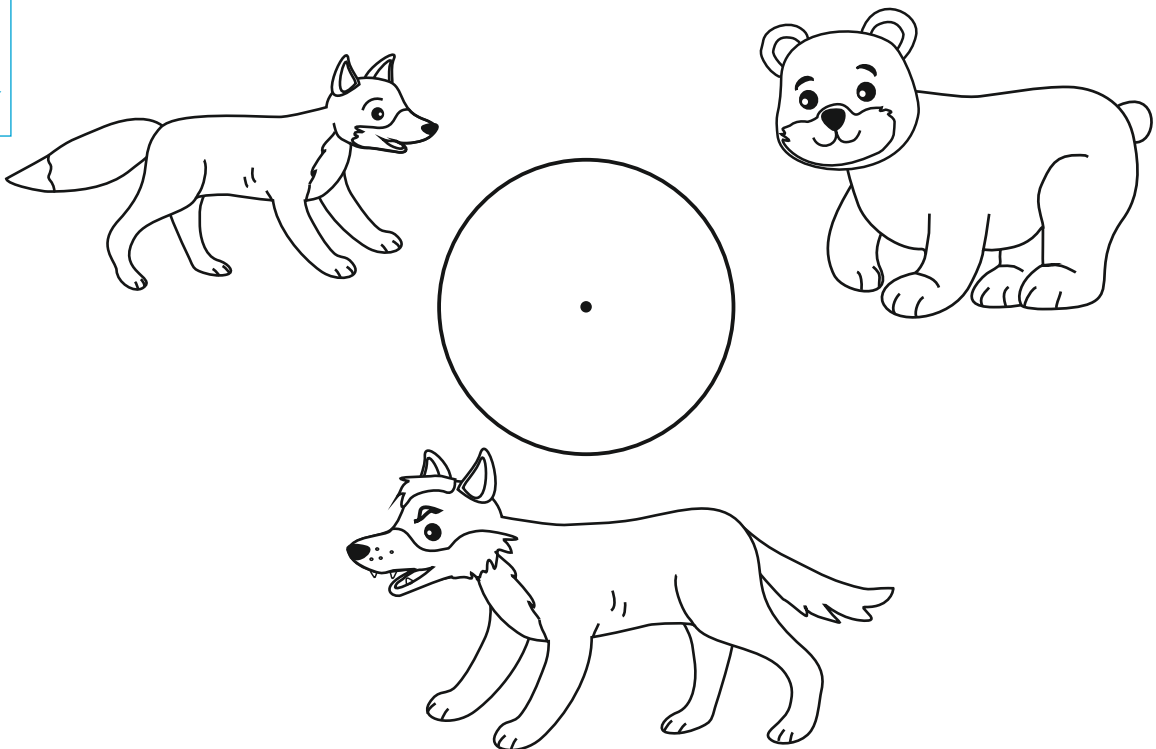
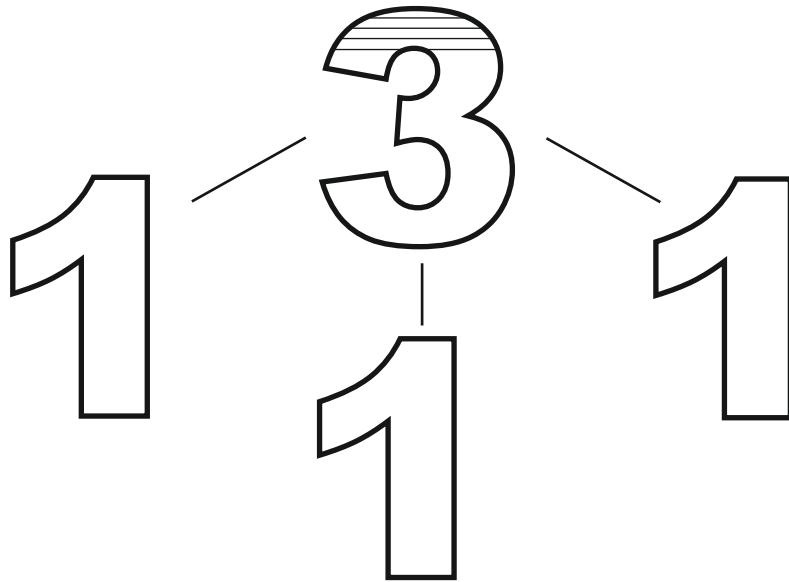

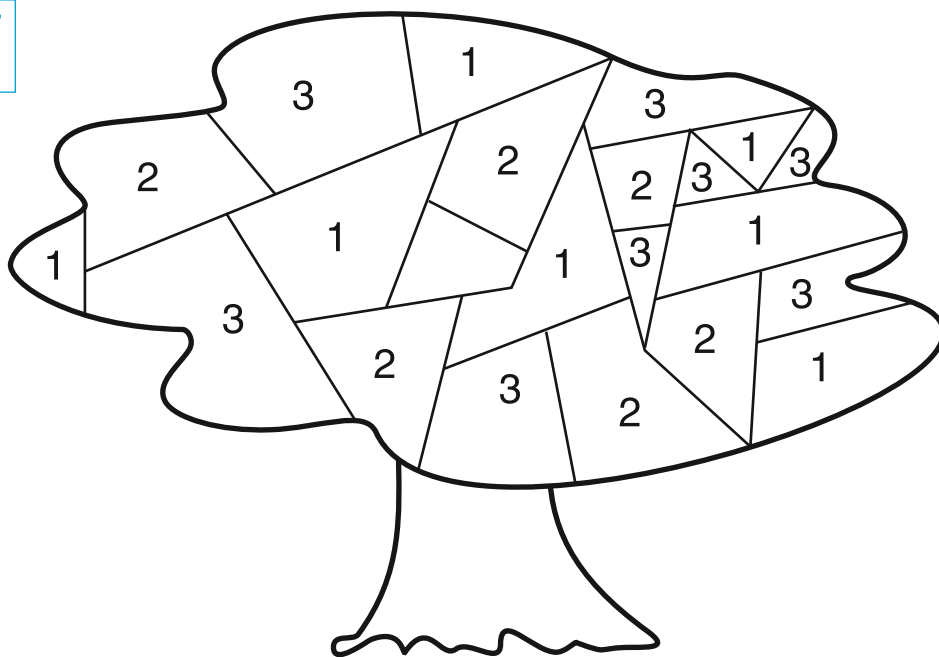
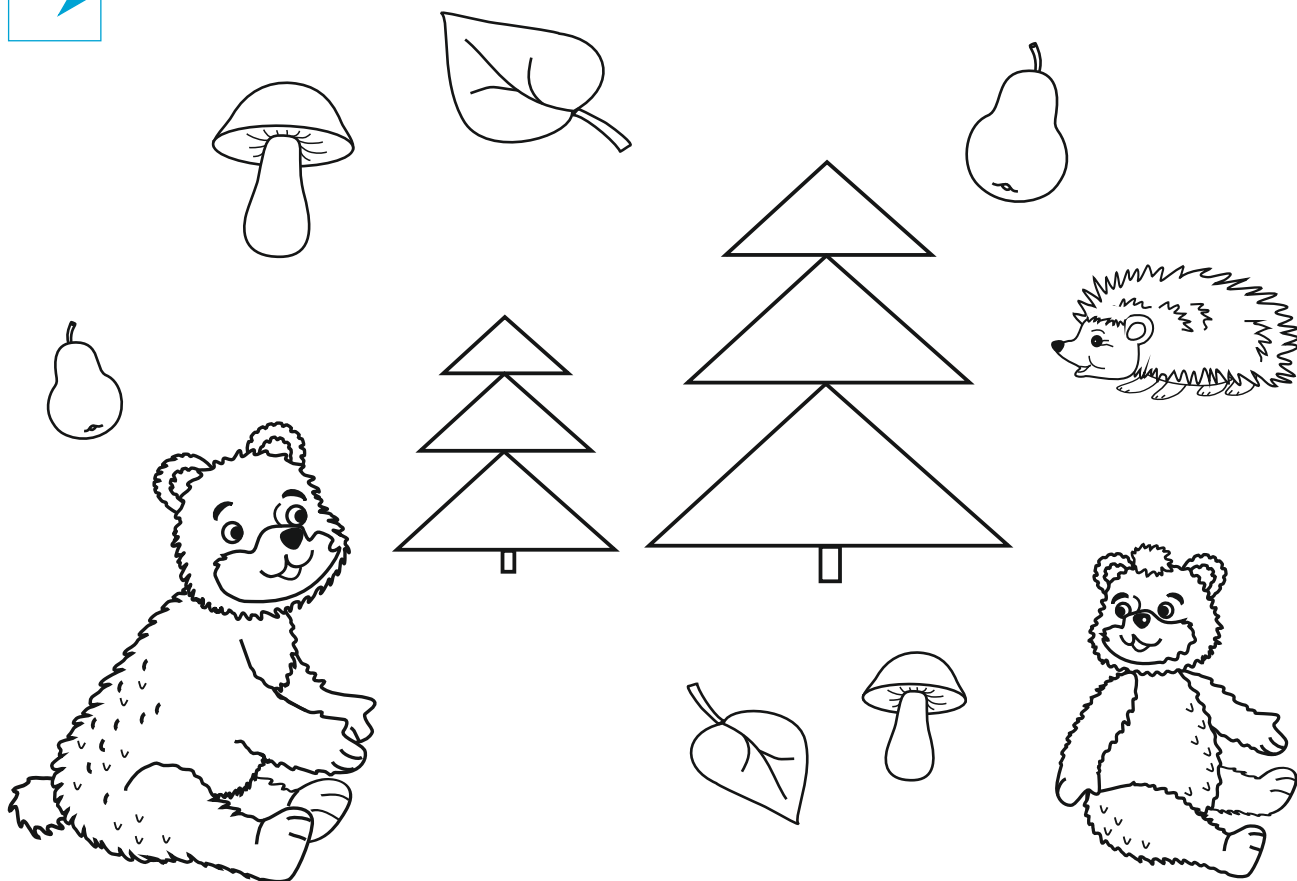

ЗАНЯТКИ 10

ЗАНЯТИЕ 10

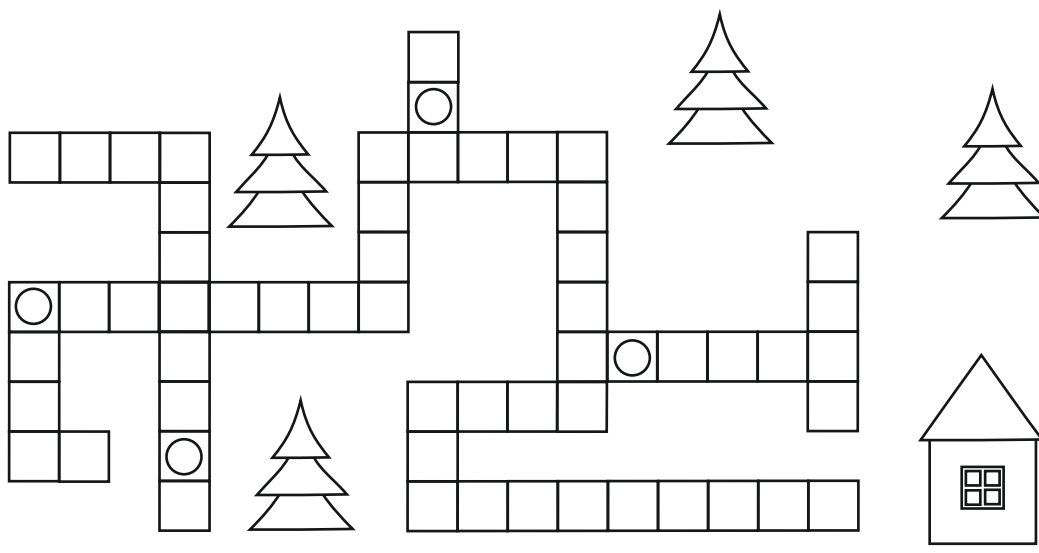
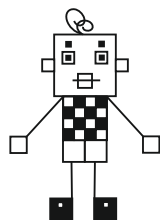
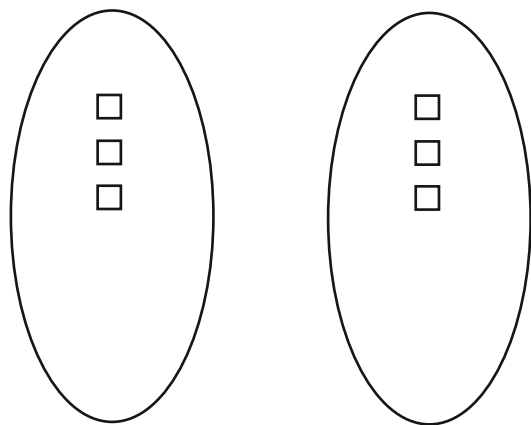

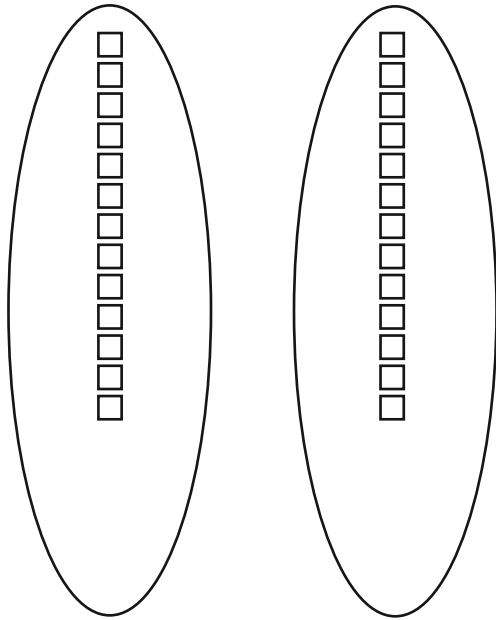

13

14

13 13

14 14

10 11

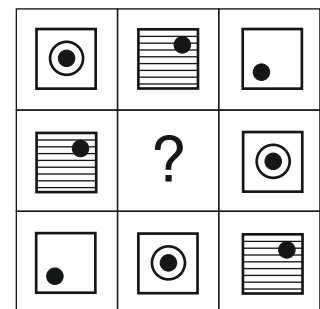
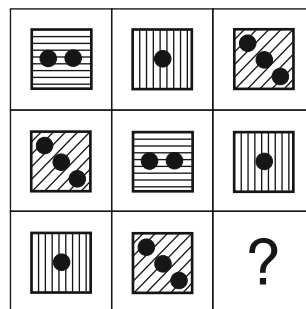
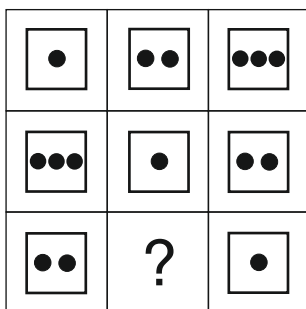
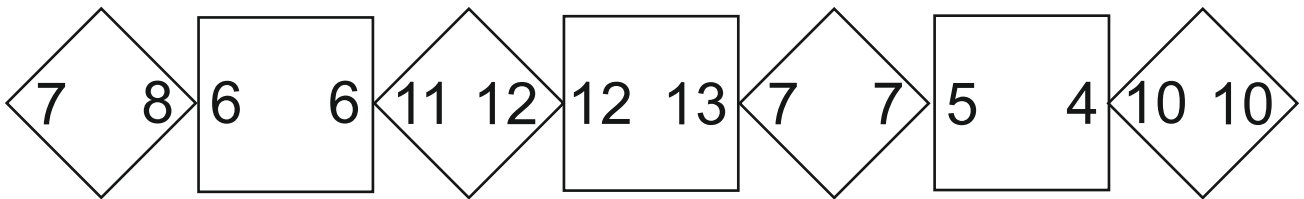

ЗАНЯТКИ 11

ЗАНЯТИЕ 11

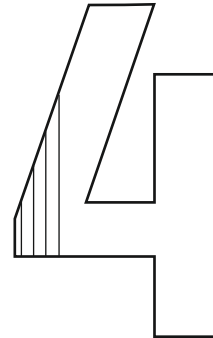
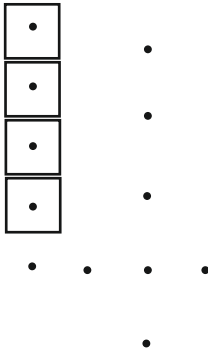
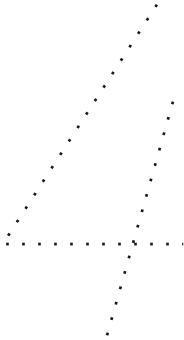

A large empty rectangular box for a drawing or activity. In the center of this box is a smaller, empty rectangular box.



1		
4		
3		
2		

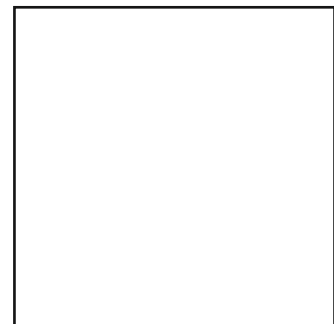
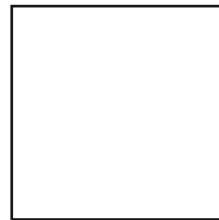
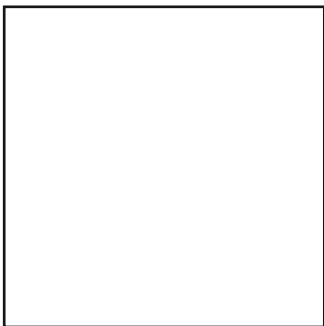
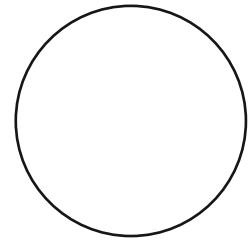
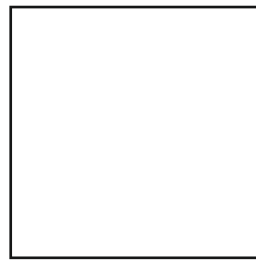
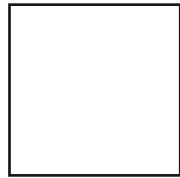
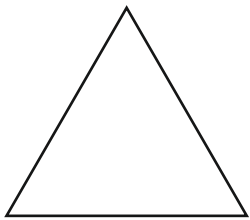
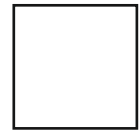
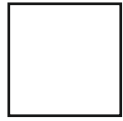
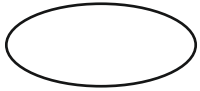
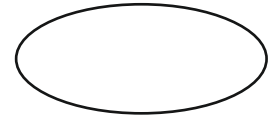
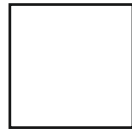
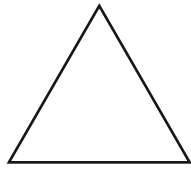

ЗАНЯТКИ 12

ЗАНЯТИЕ 12

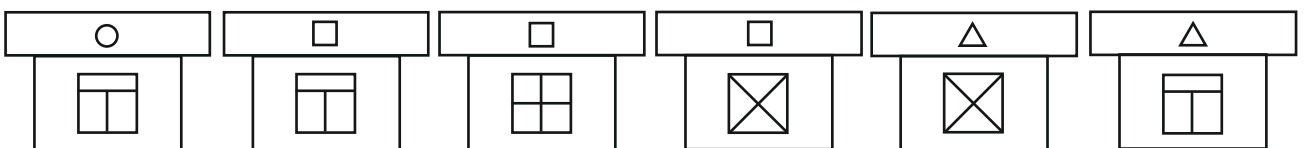
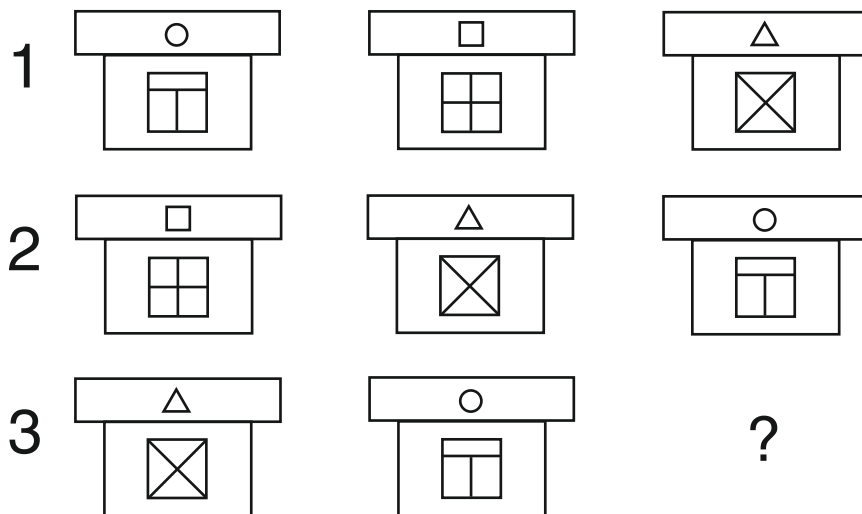
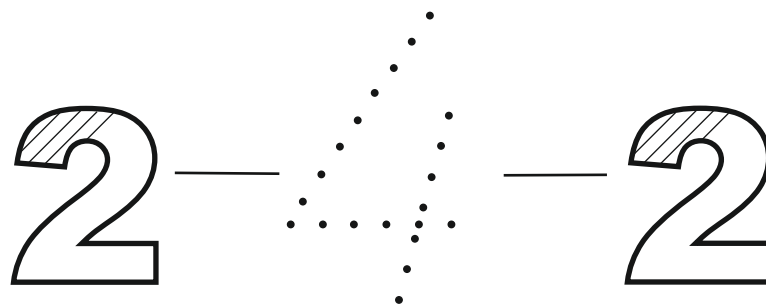
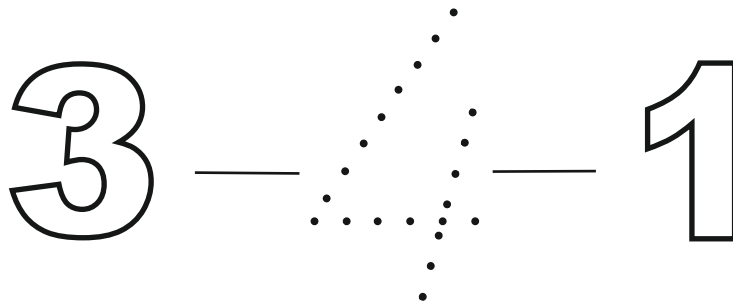

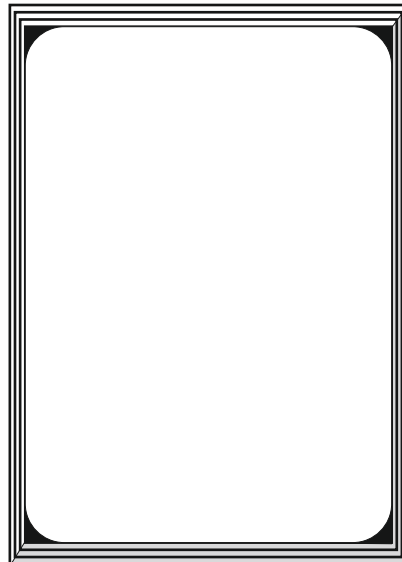
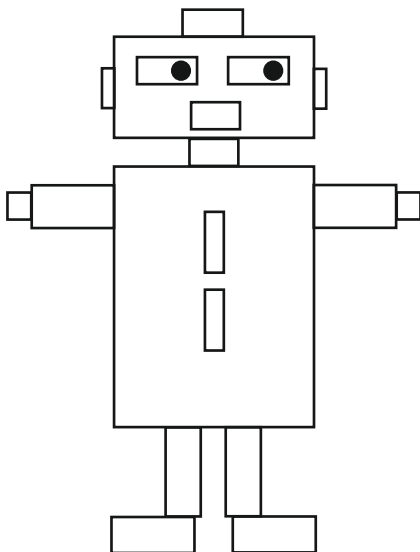
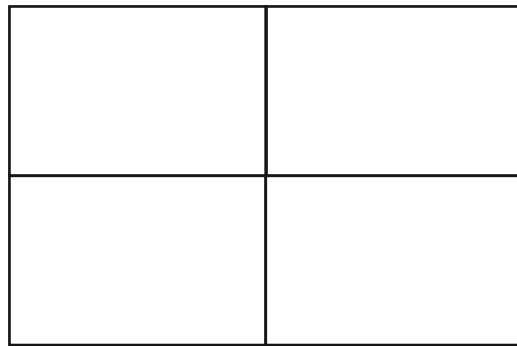
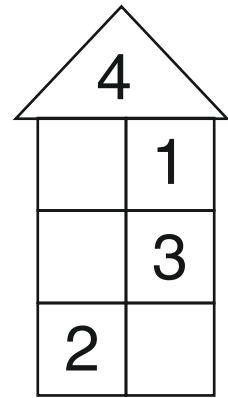
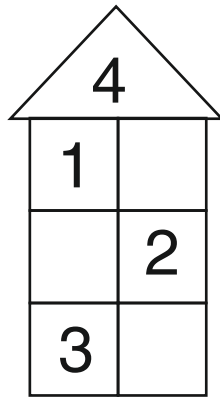
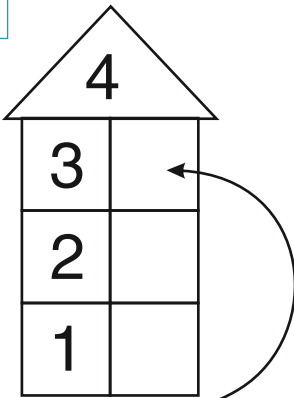

ЗАНЯТКІ 13

ЗАНЯТІЕ 13

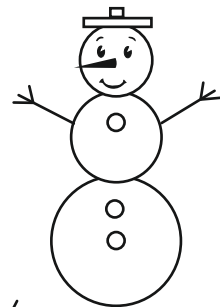
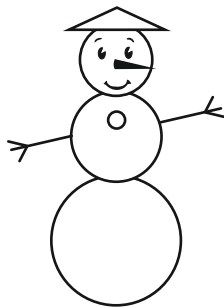
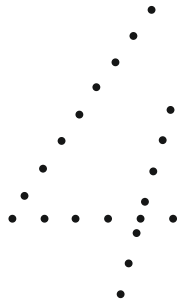
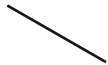
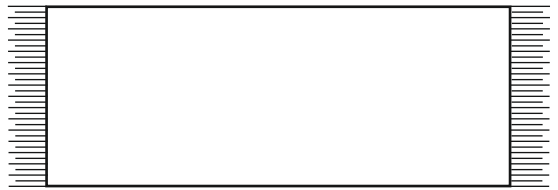

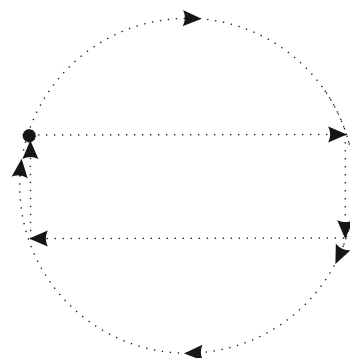
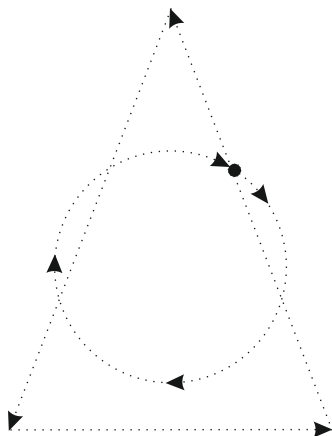
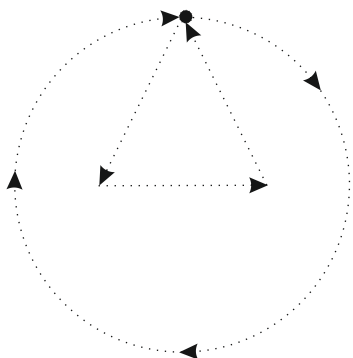
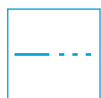
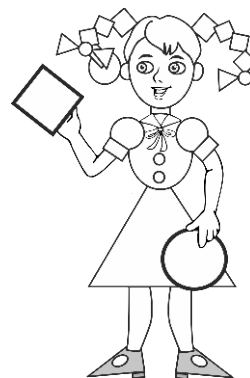
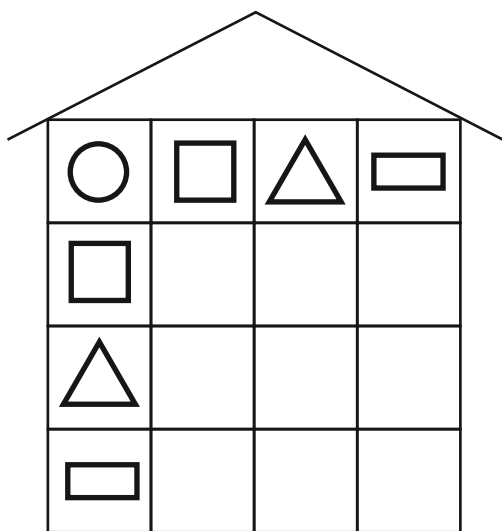
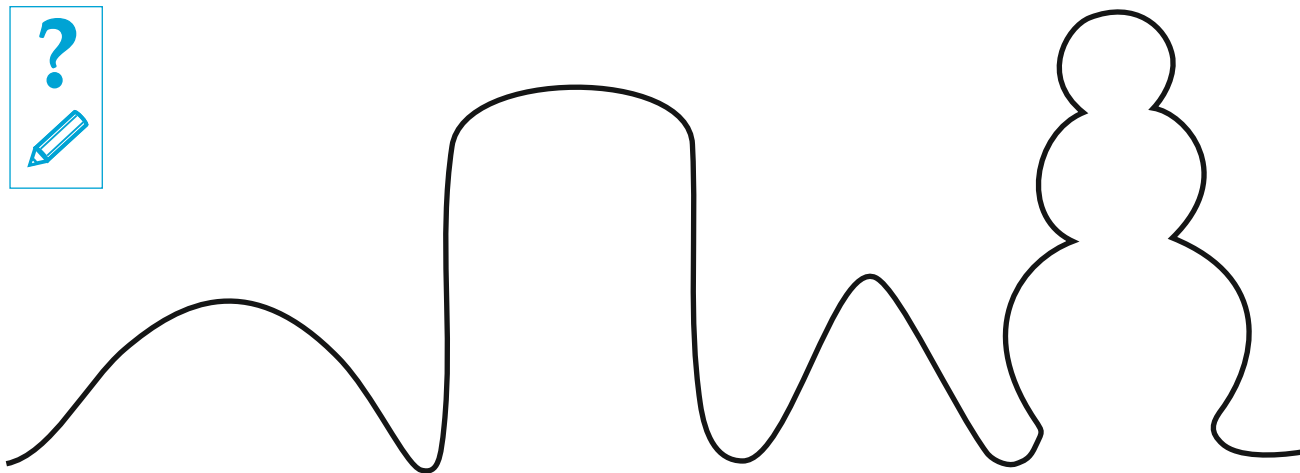

ЗАНЯТКИ 14

ЗАНЯТИЕ 14

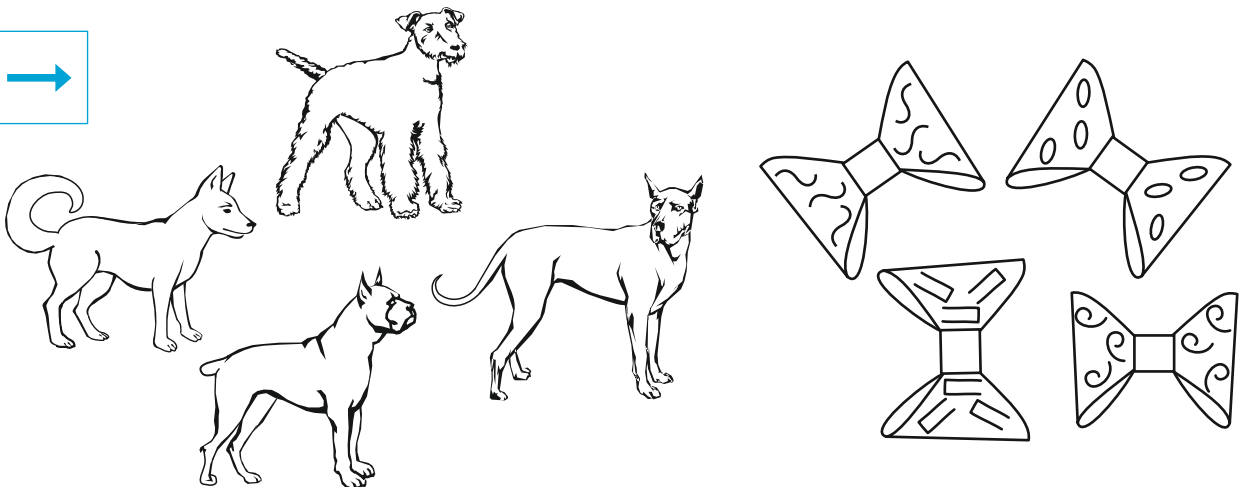
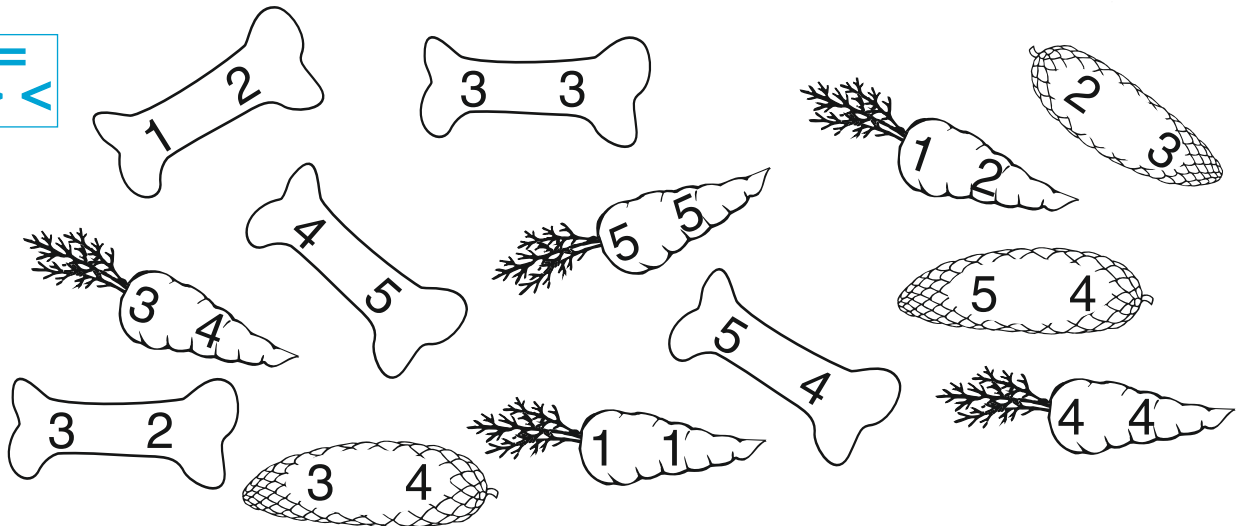
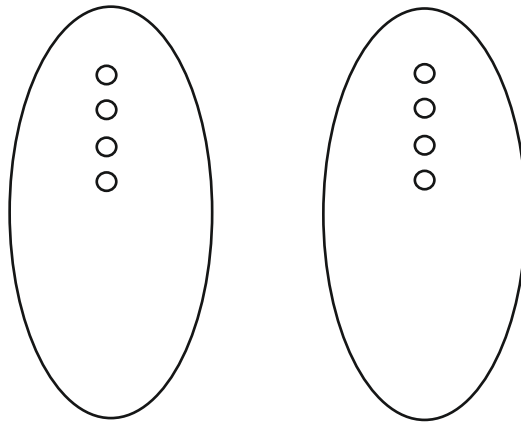

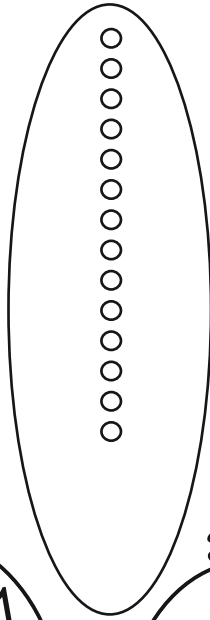
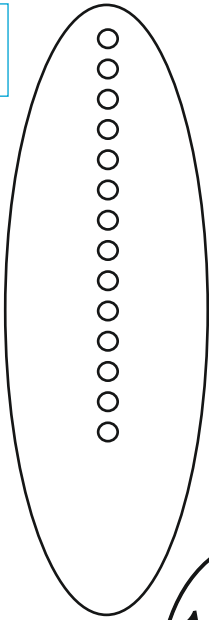

14

15

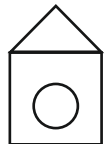
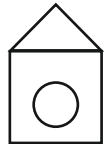
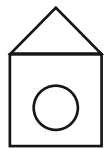
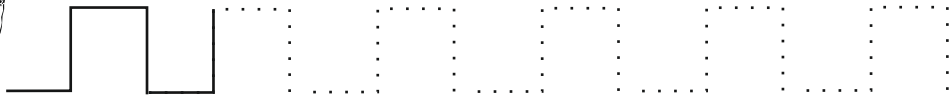
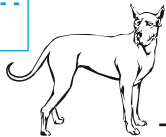
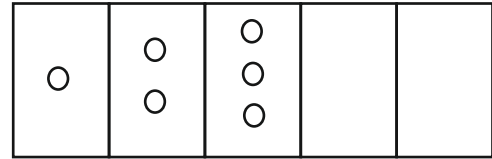
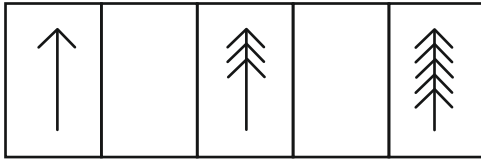
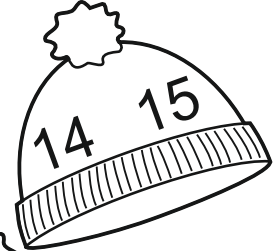
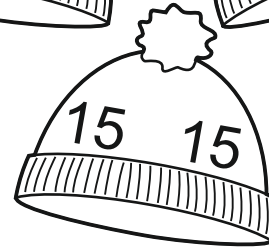
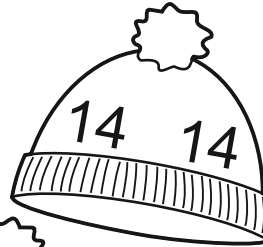
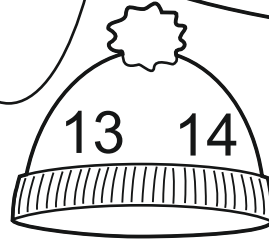
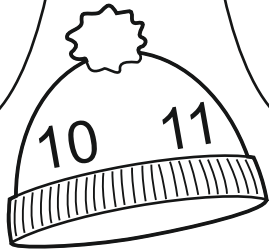

ЗАНЯТКИ 15

ЗАНЯТИЕ 15

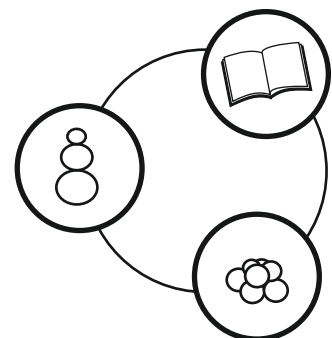
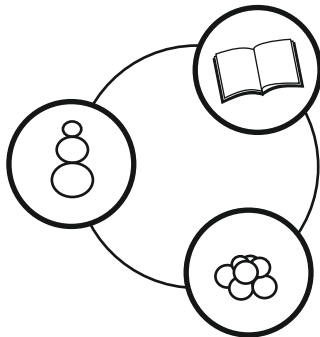
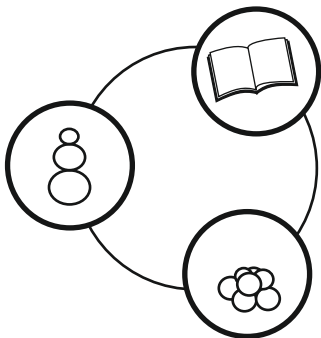
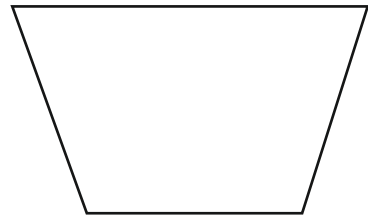
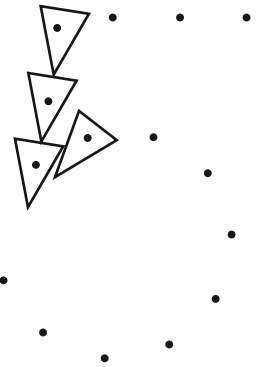
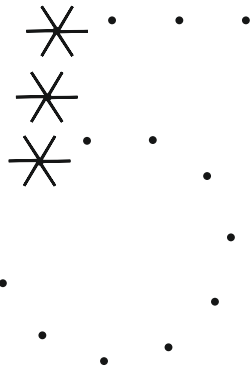
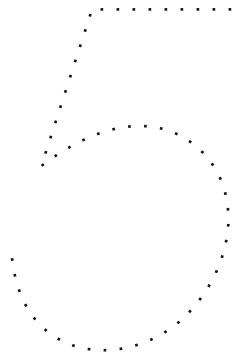

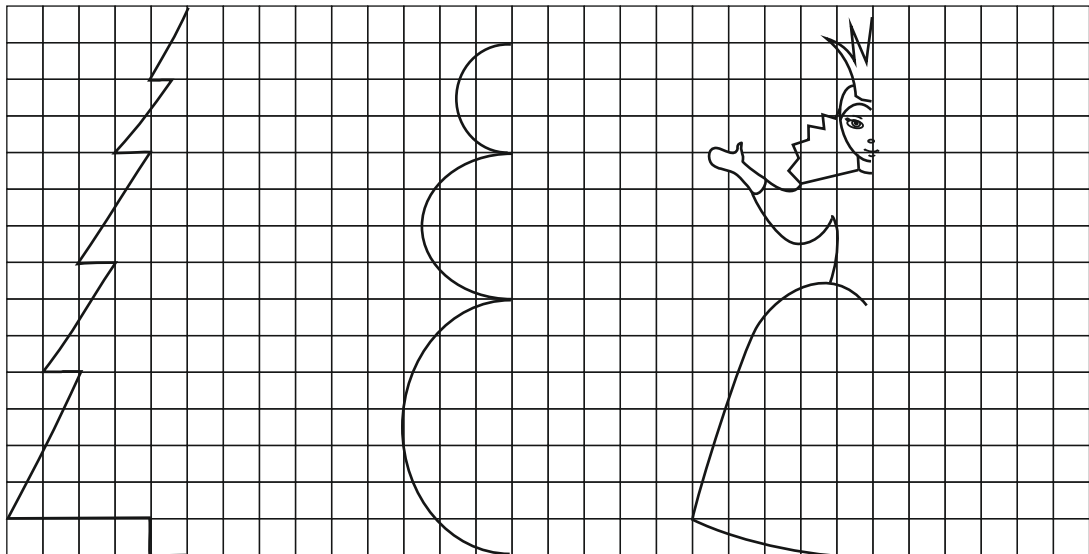
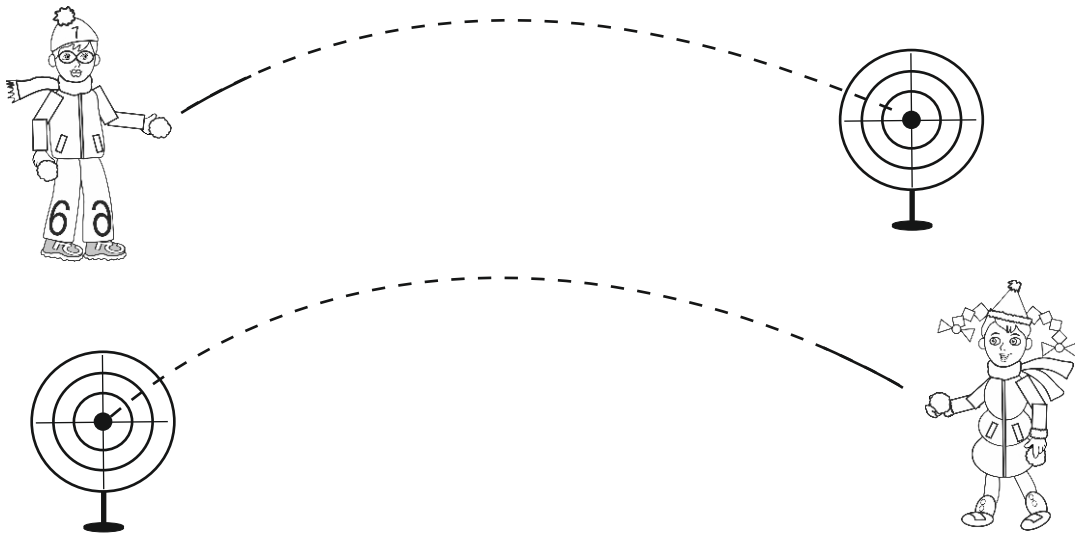
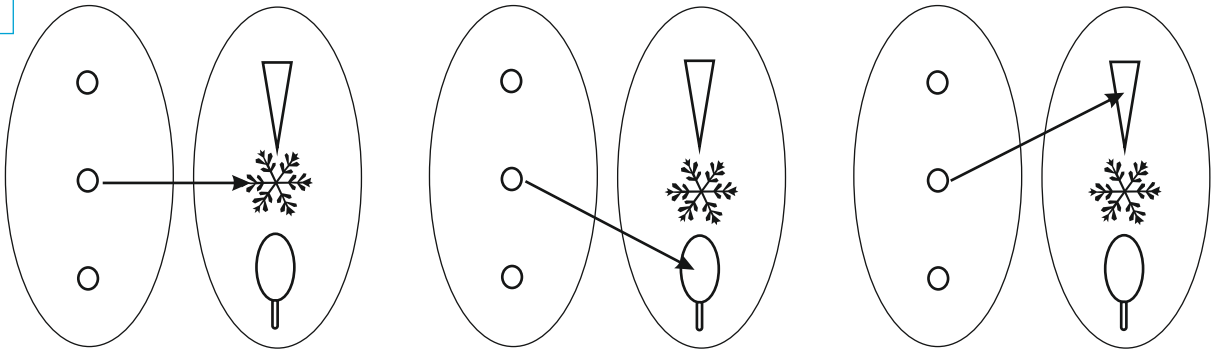

ЗАНЯТКИ 16

ЗАНЯТИЕ 16

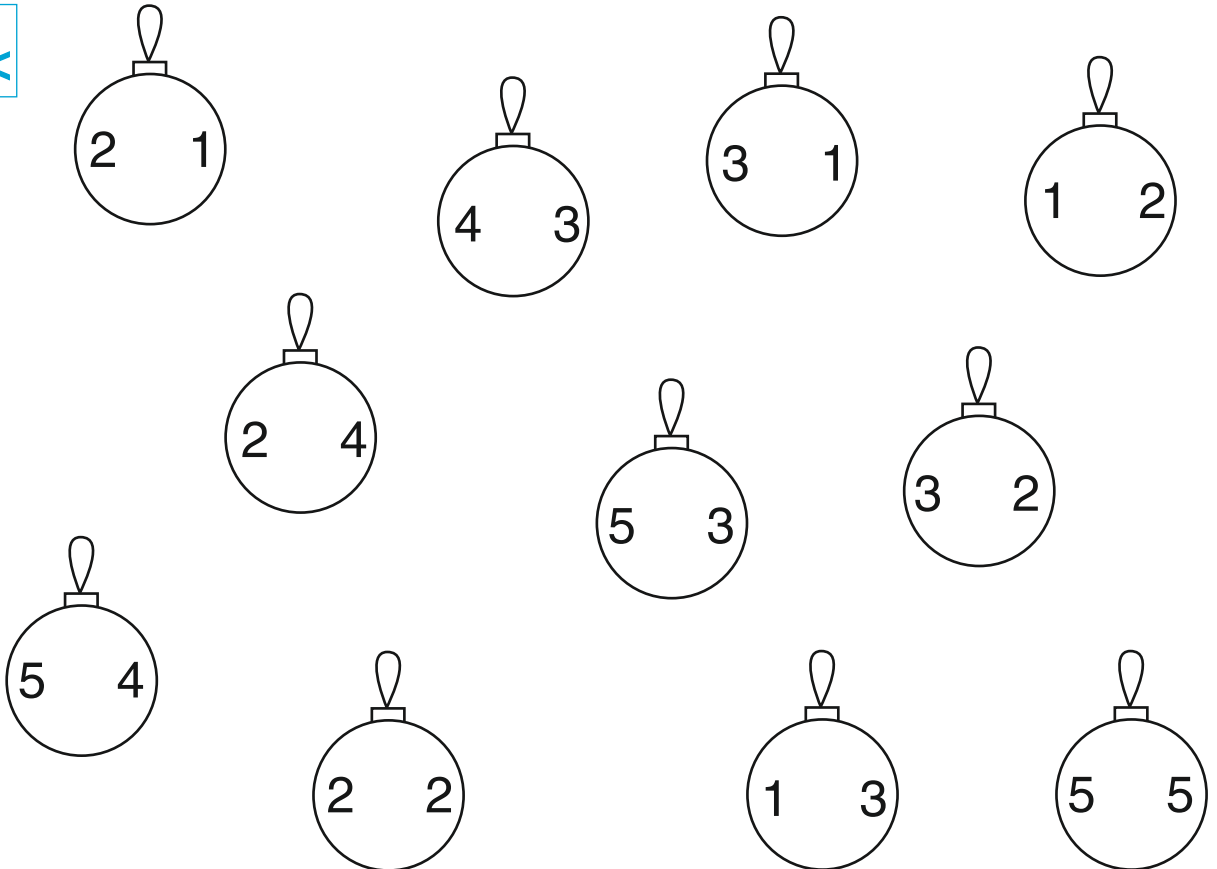
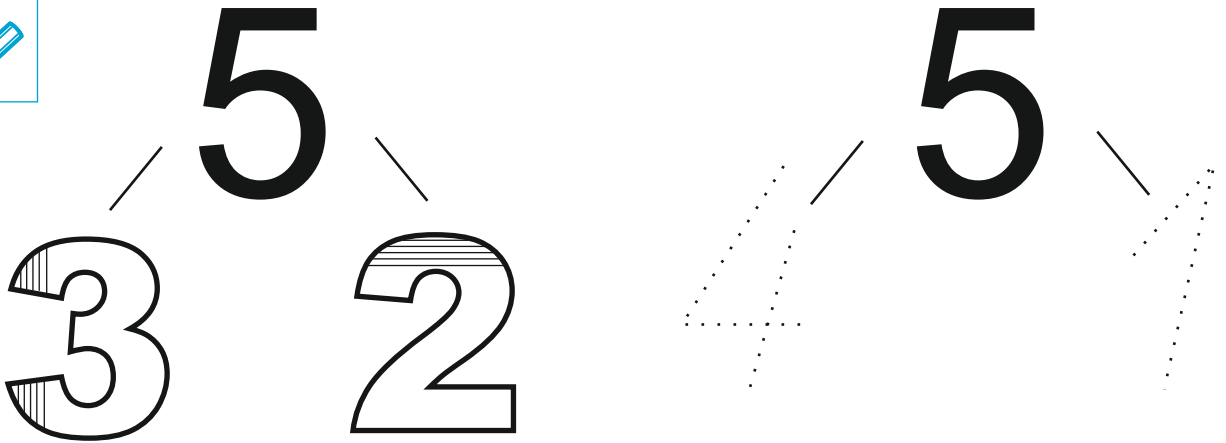

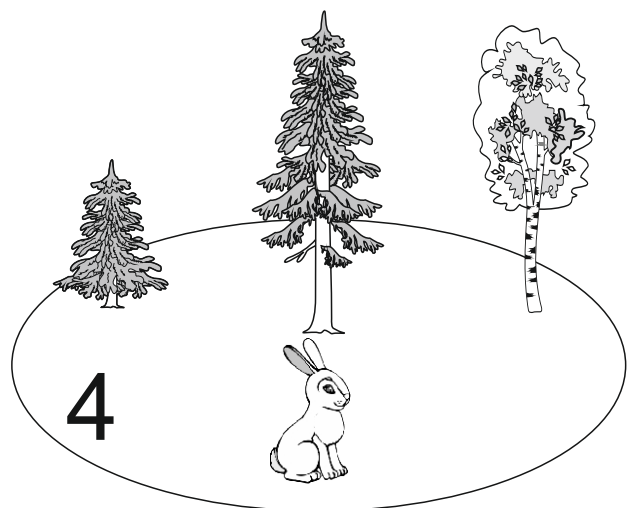
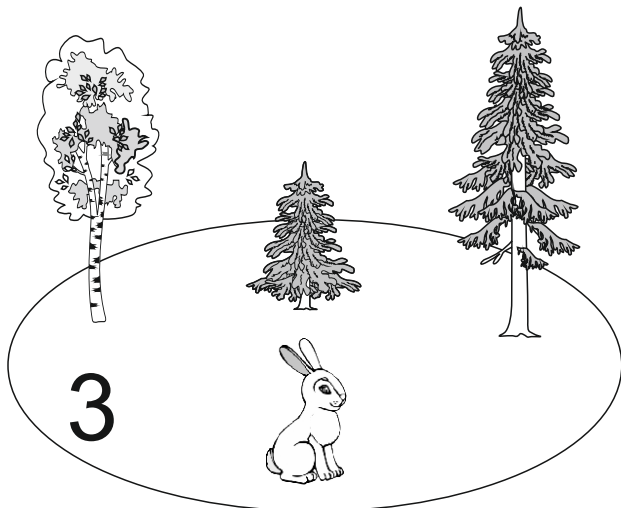
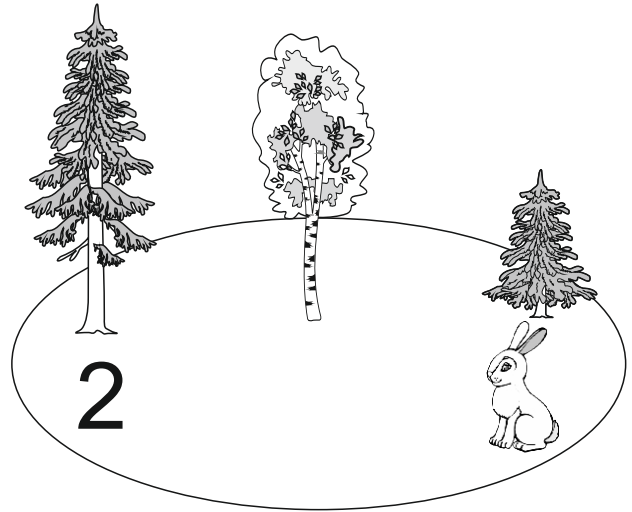
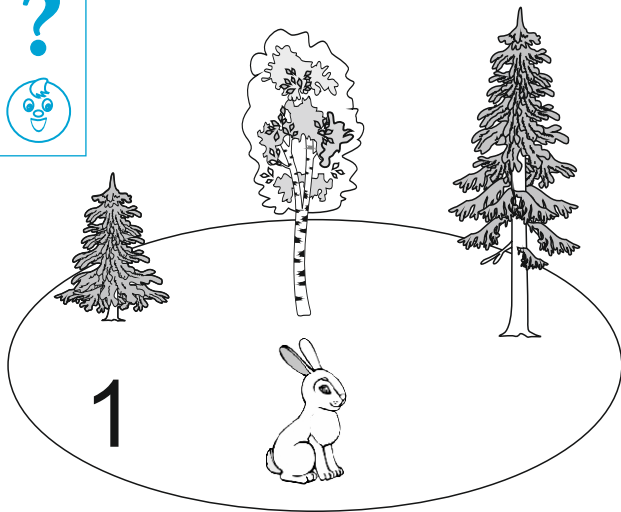
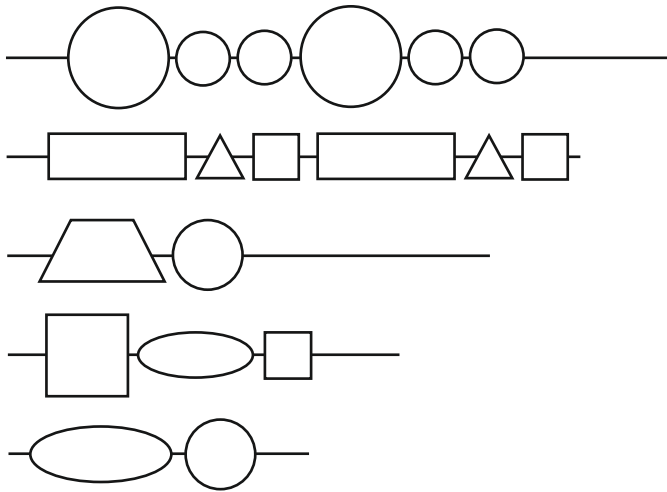

ЗАНЯТКИ 17

ЗАНЯТИЕ 17

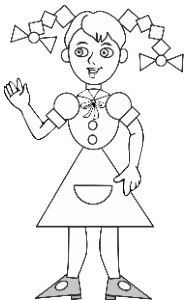
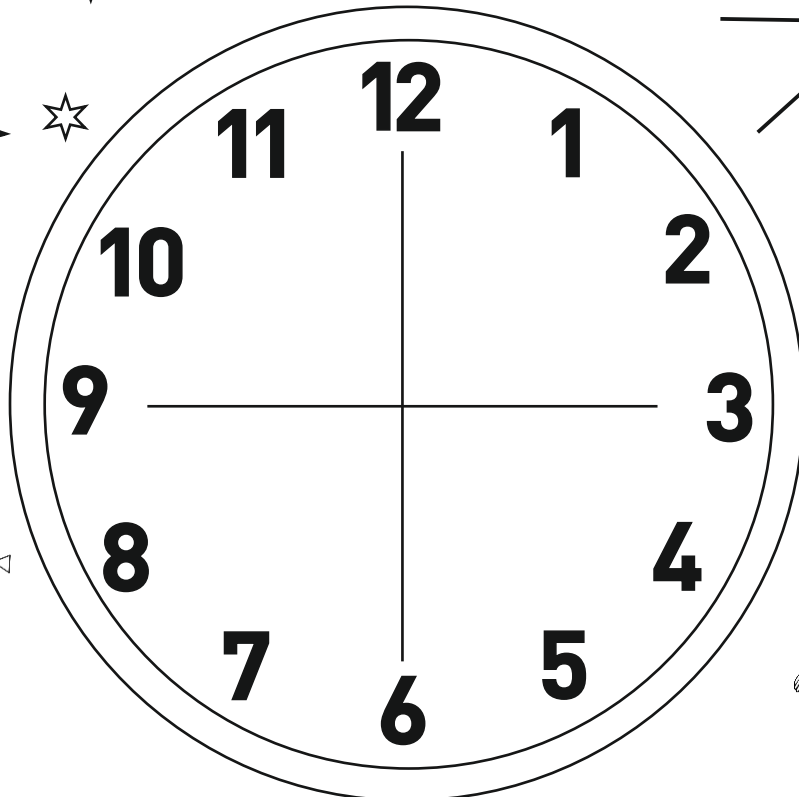
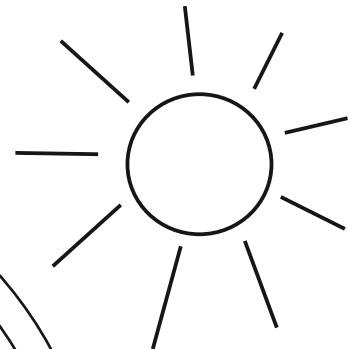
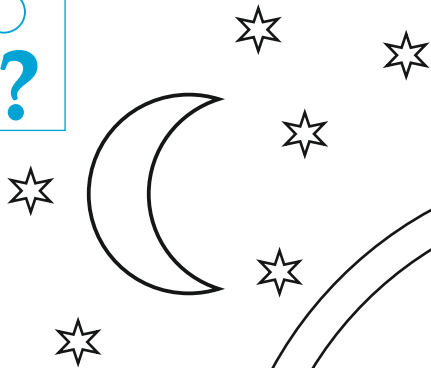
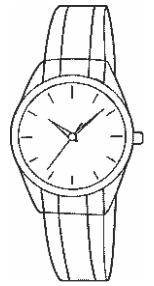
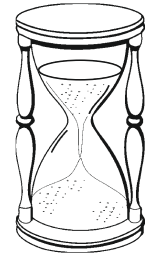
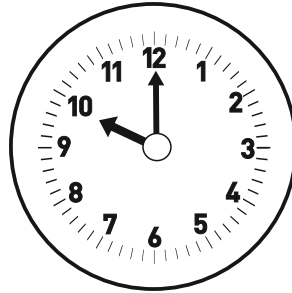
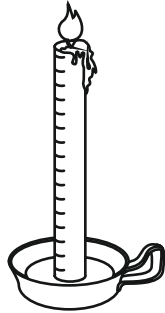
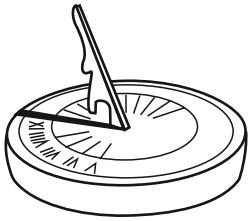

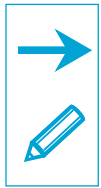

12
11
10
9
8
7

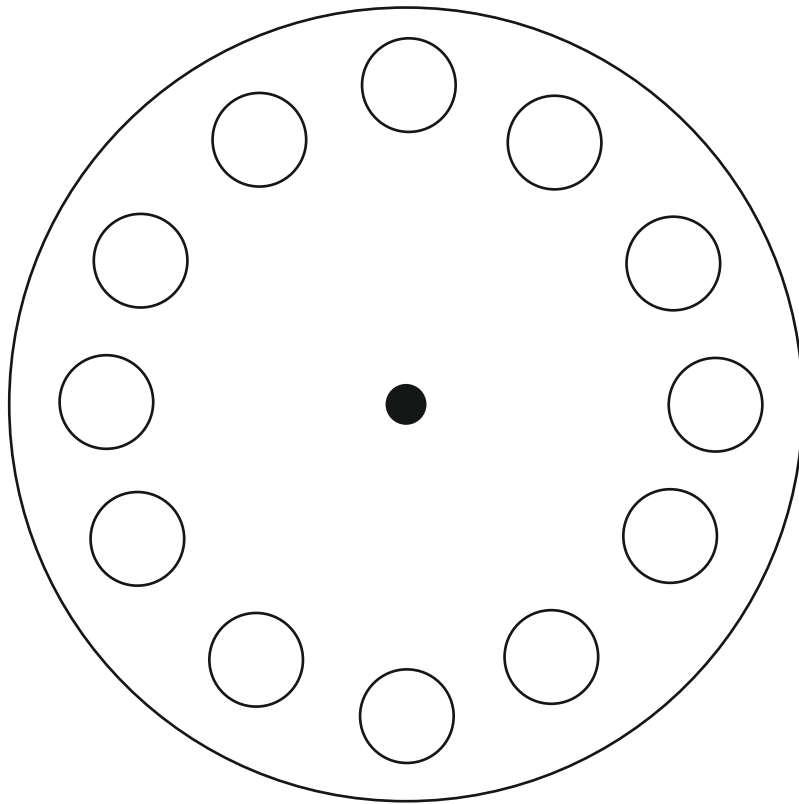

1
2
3
4
5
6



ЗАНЯТКИ 18

ЗАНЯТИЕ 18

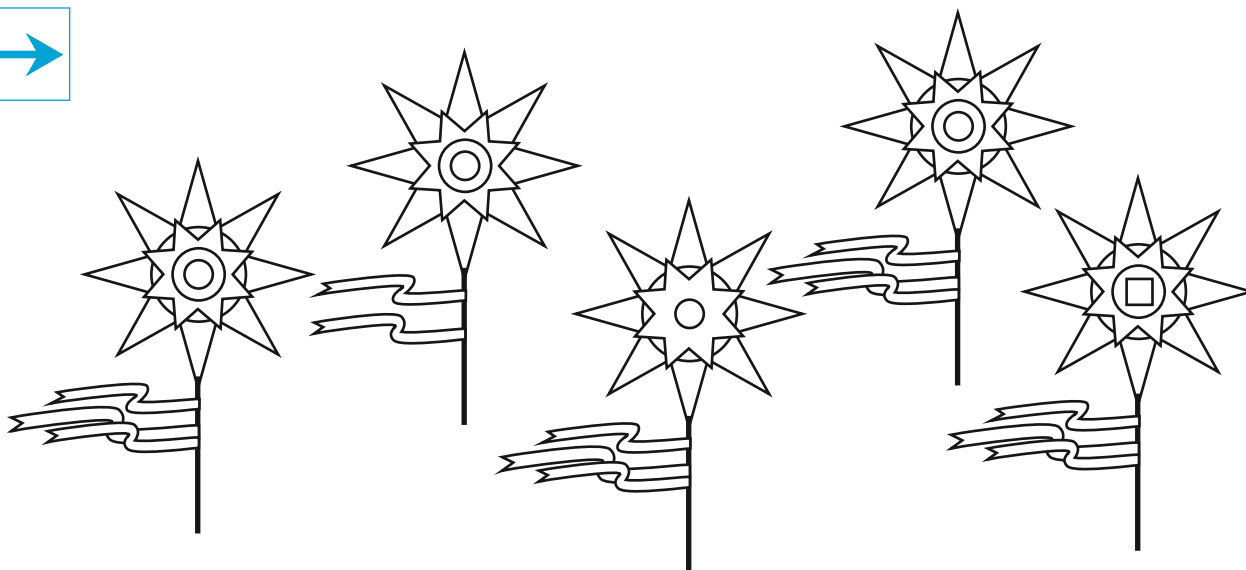
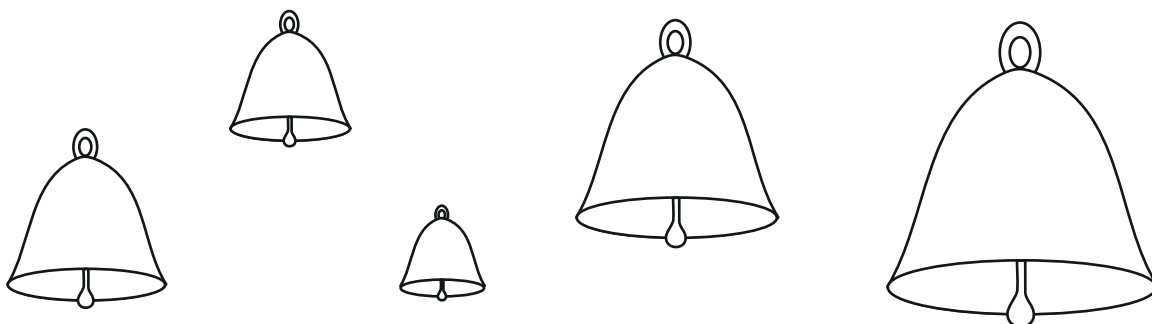
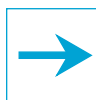
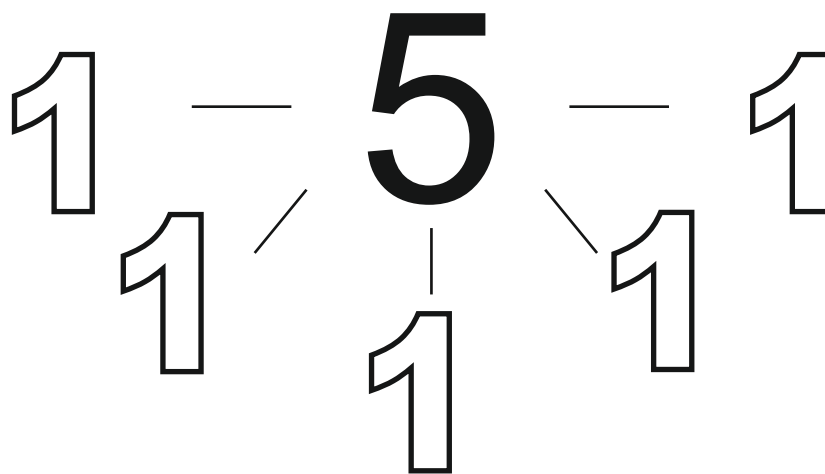



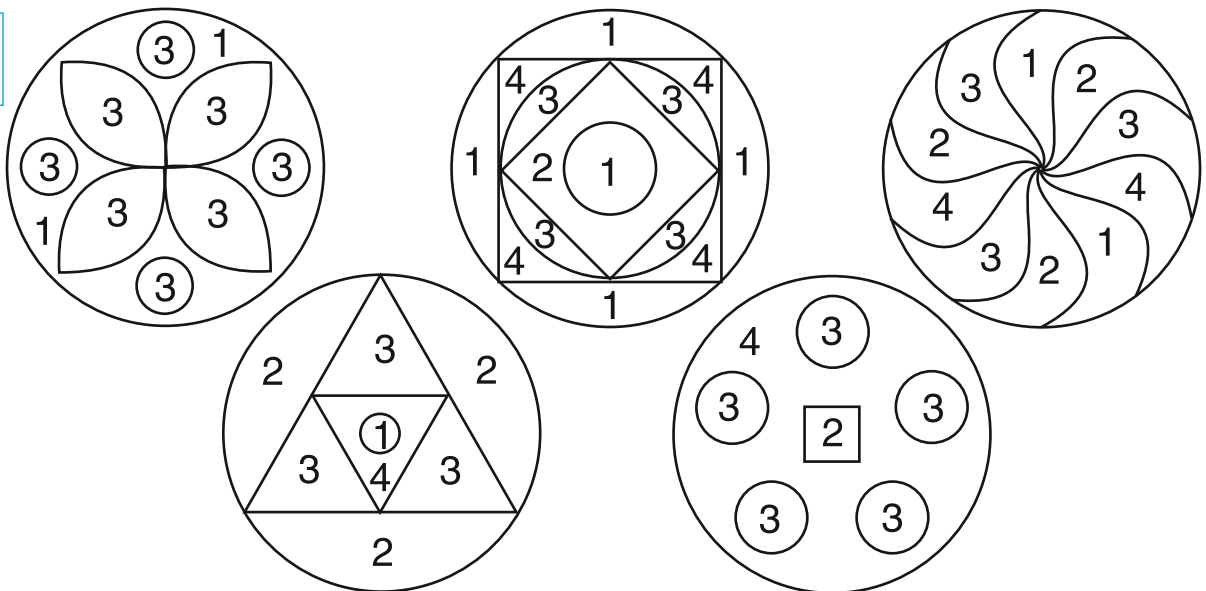

ЗАНЯТКИ 19

ЗАНЯТИЕ 19

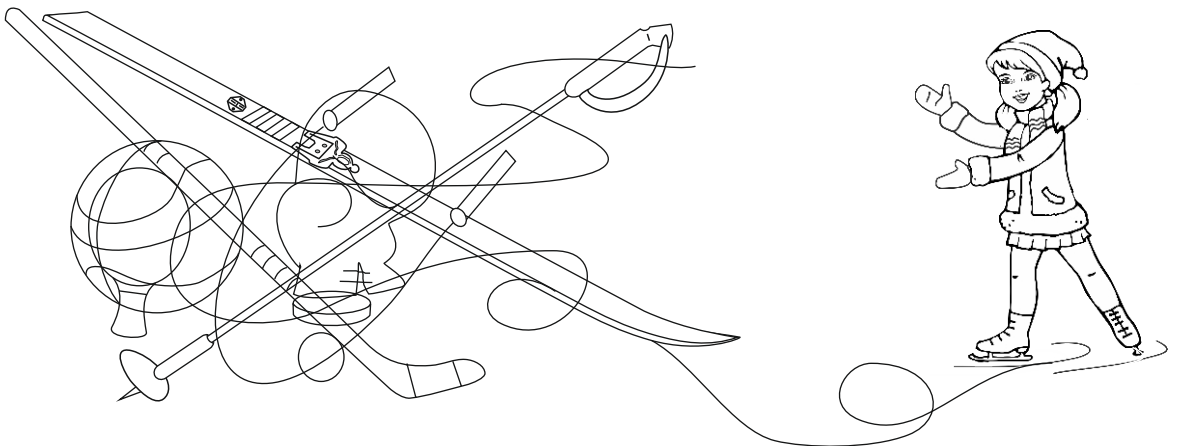
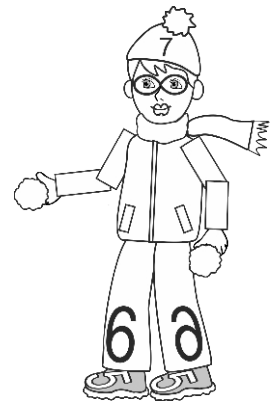
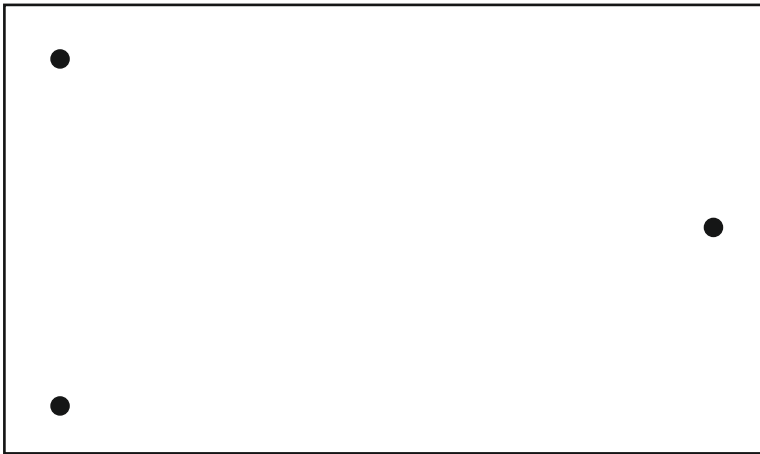
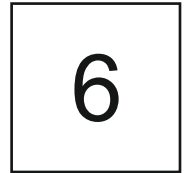
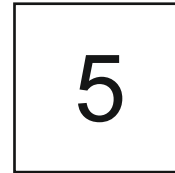
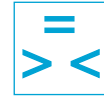
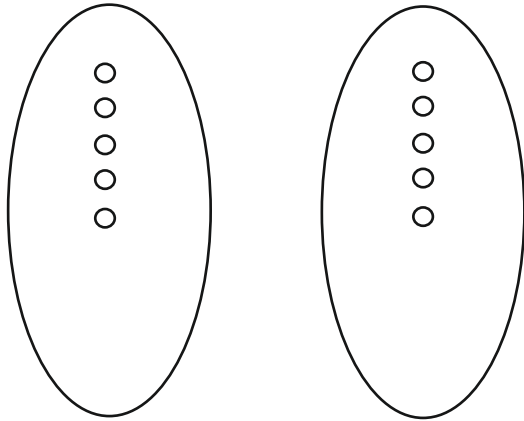

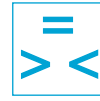
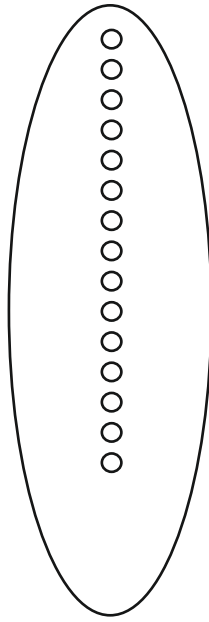
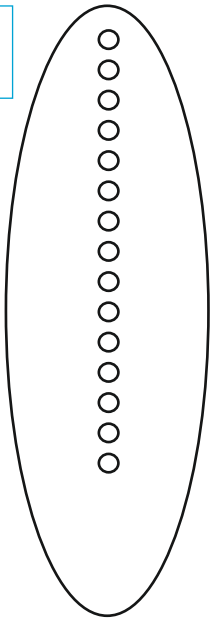

15

16

15 15

12 13

16 16

14 15



 	6	

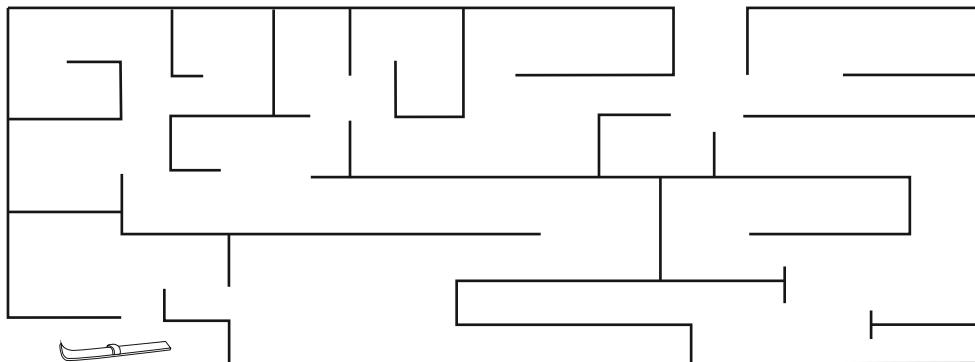

ЗАНЯТКИ 20

ЗАНЯТИЕ 20



○	□	▭
△	○	○
○	□	△

○	□	△	○	▭
○	□	○	□	▭

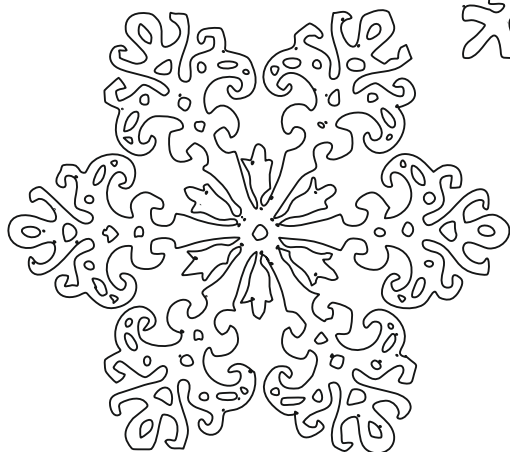
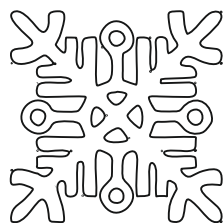
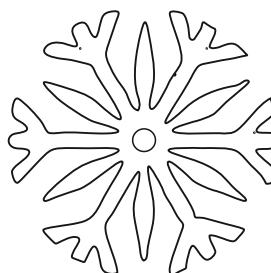
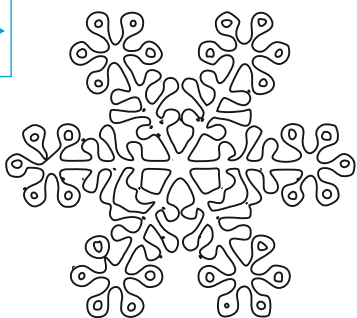

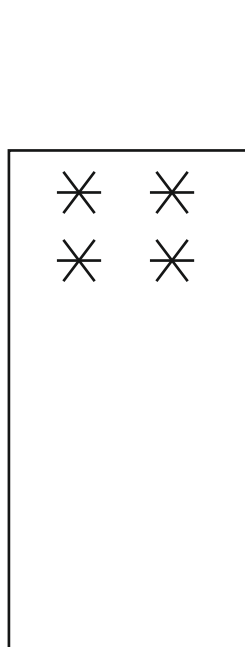
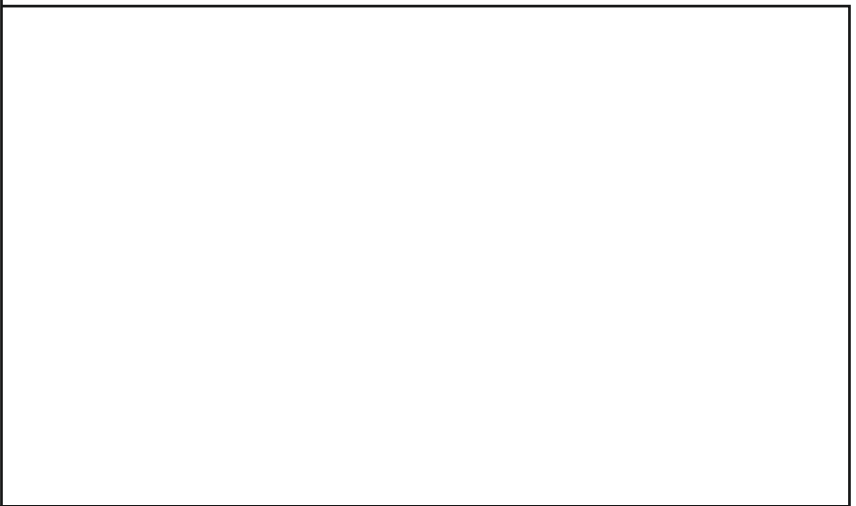
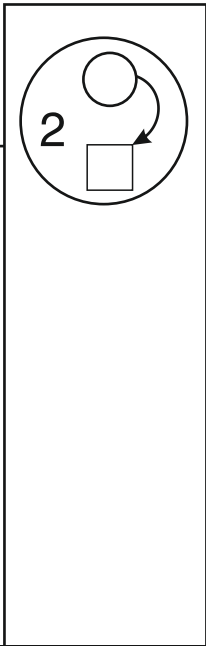
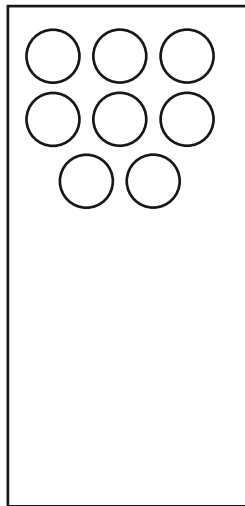
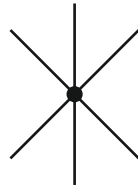
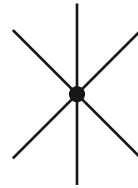
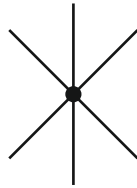
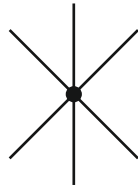
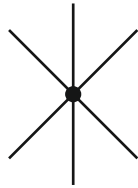
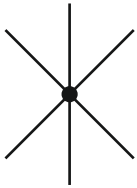

ЗАНЯТКИ 21

ЗАНЯТИЕ 21

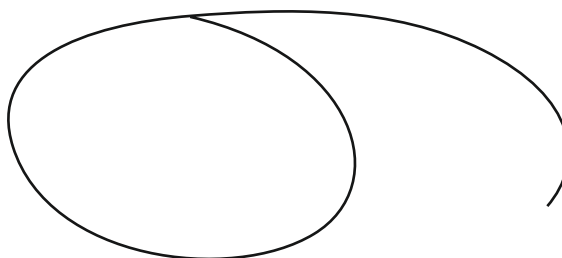
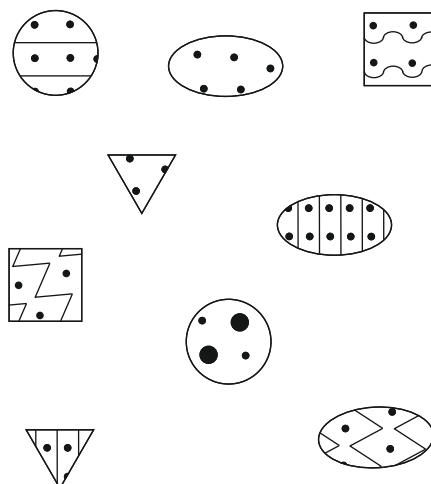
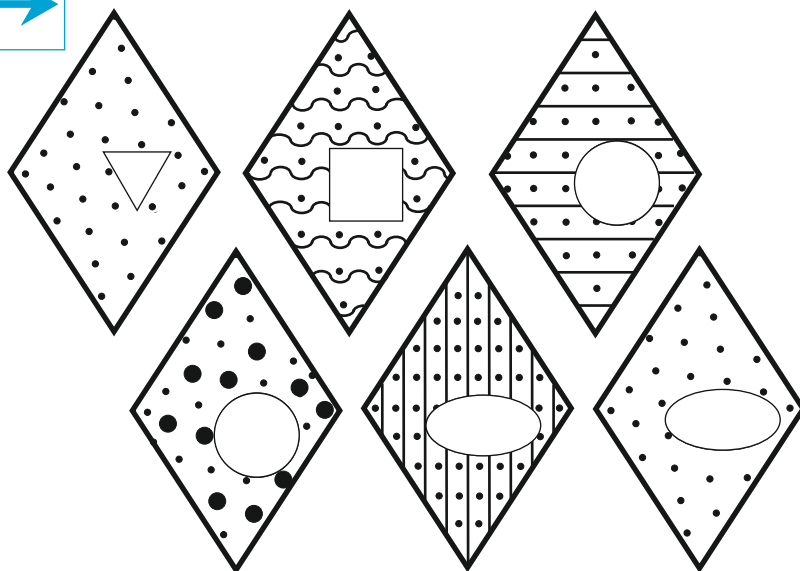
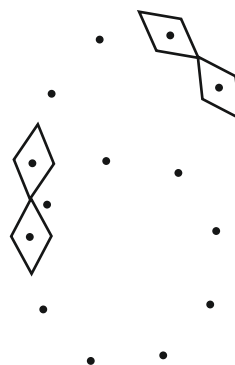
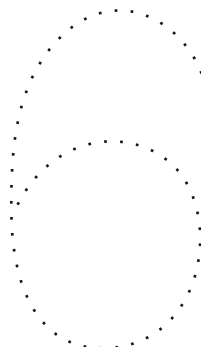
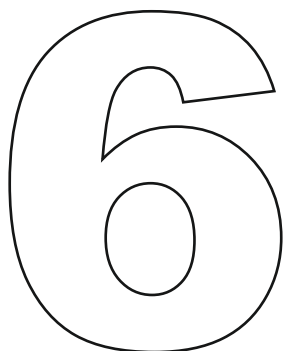

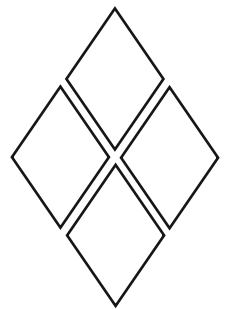
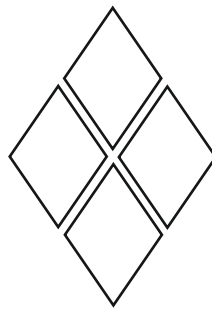
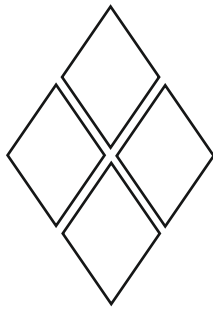
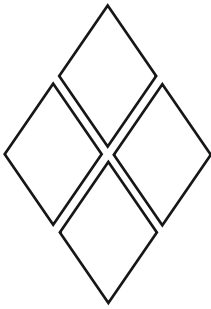

16

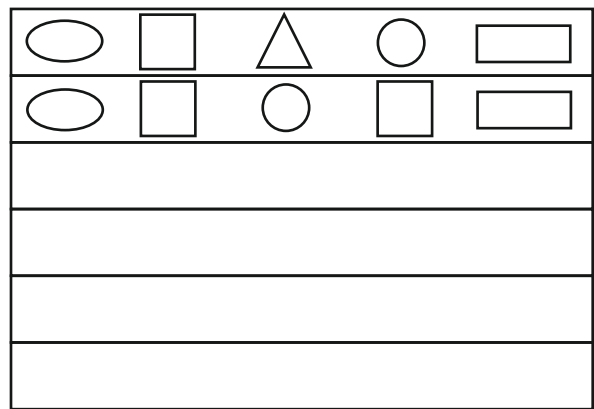
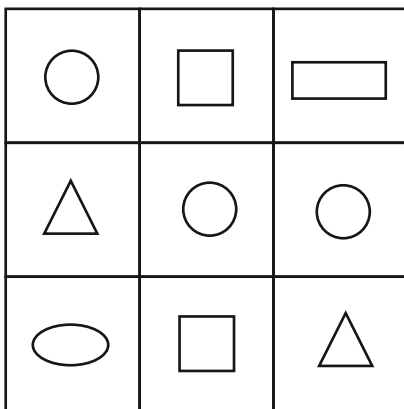
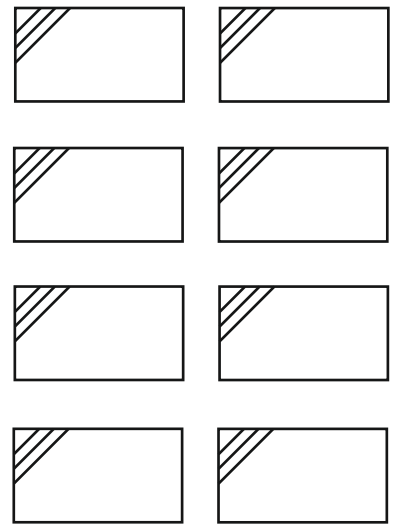
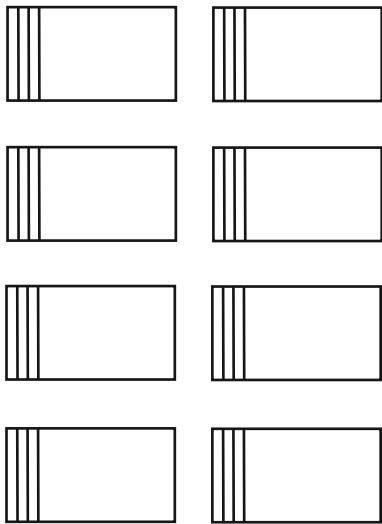

ЗАНЯТКИ 22

ЗАНЯТИЕ 22



1
2
4
6

2
3
4
4



6
6
4
3

5
3
1
5

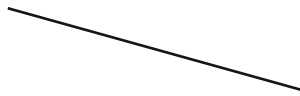
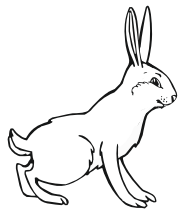
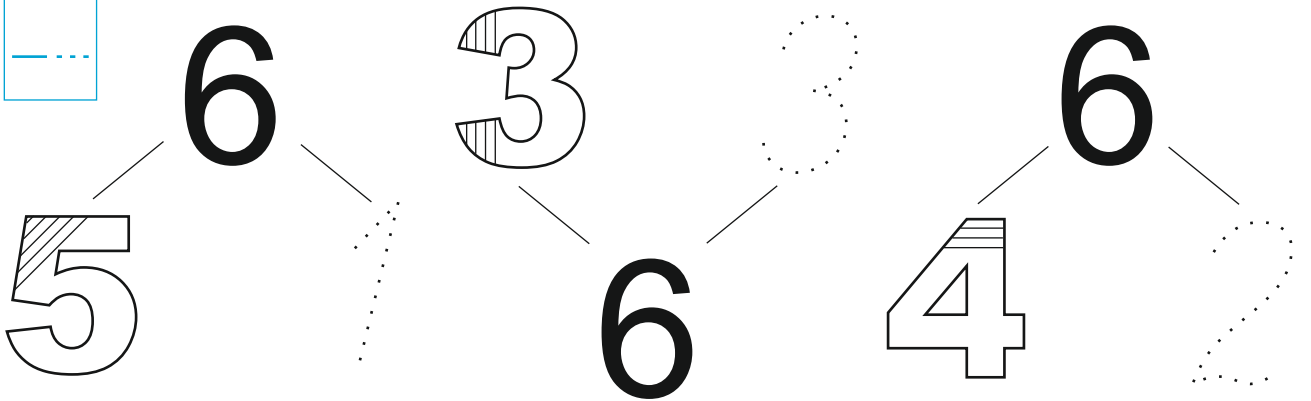



$7 + 1 =$

$9 - 1 =$

$5 + 1 =$

$6 - 1 =$

$5 - 1 =$

- 1
- 2
- 3
- 4
- 5
- 6
- 7
- 8
- 9
- 10

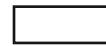

1	
3	
5	
2	
6	
4	

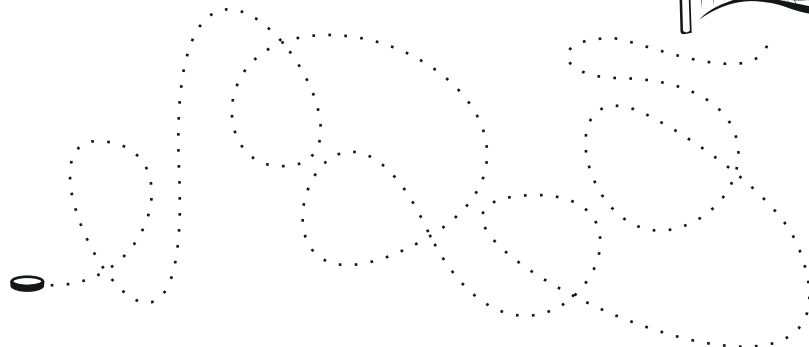
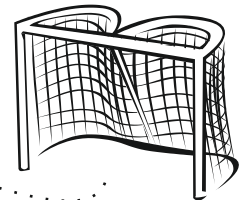

ЗАНЯТКІ 23

ЗАНЯТІЕ 23

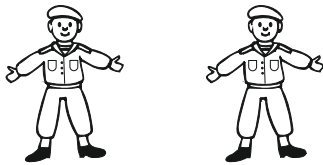
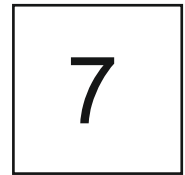
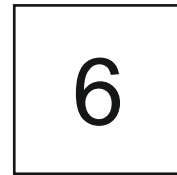
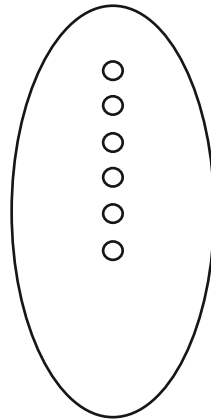
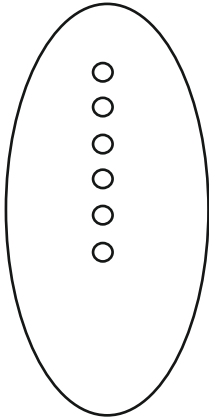

- 1
- 2
- 3
- 4
- 5
- 6
- 7

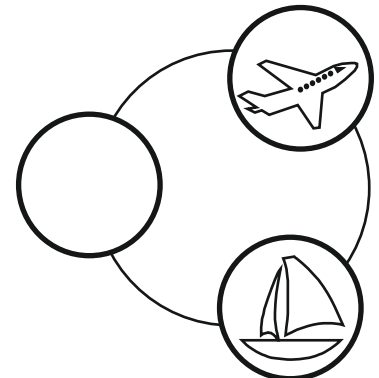
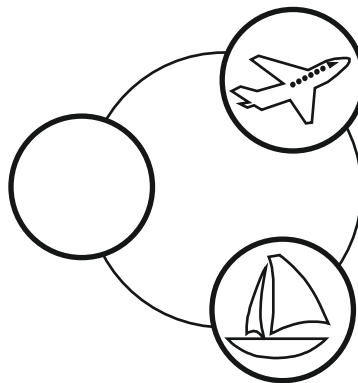
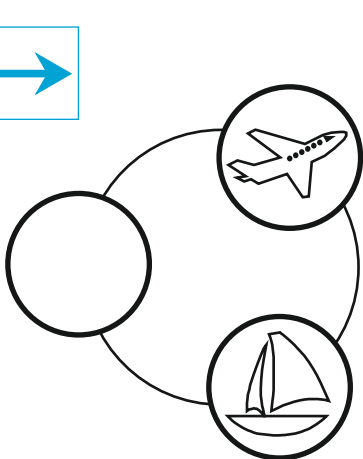
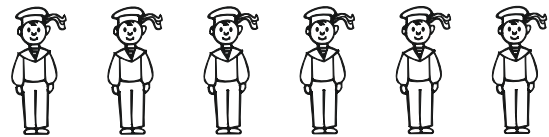

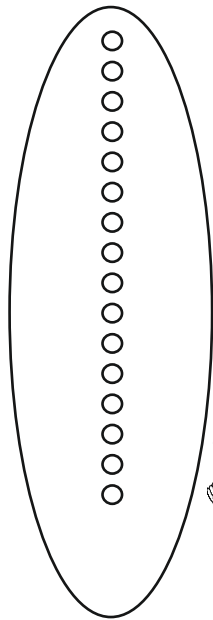
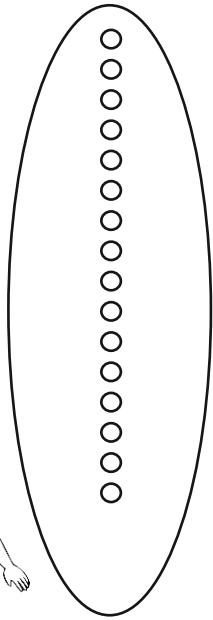

16

17

10 11

15 16

9 8

7 7

16 16

6 7



1 2 3 4 5 6 7

ЗАНЯТКІ 24

ЗАНЯТИЕ 24

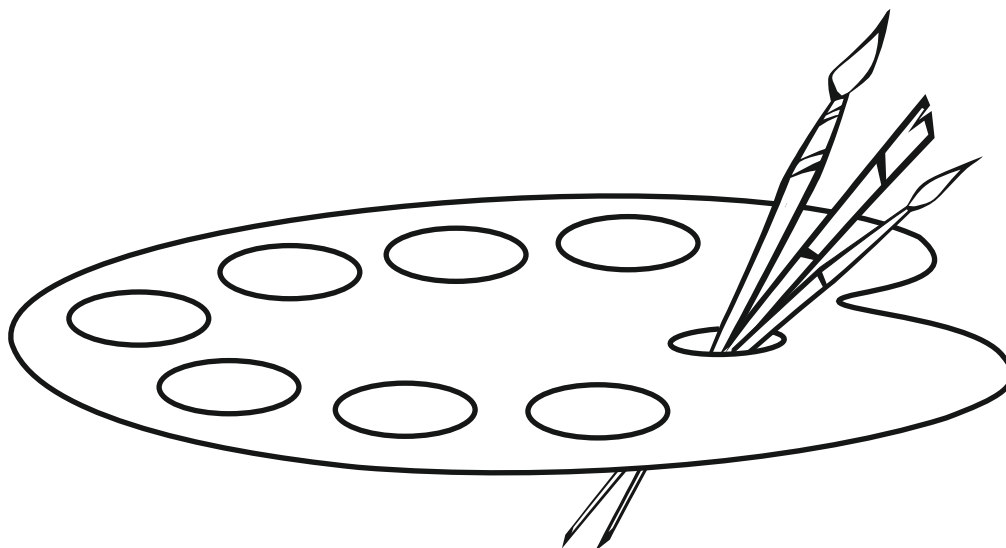
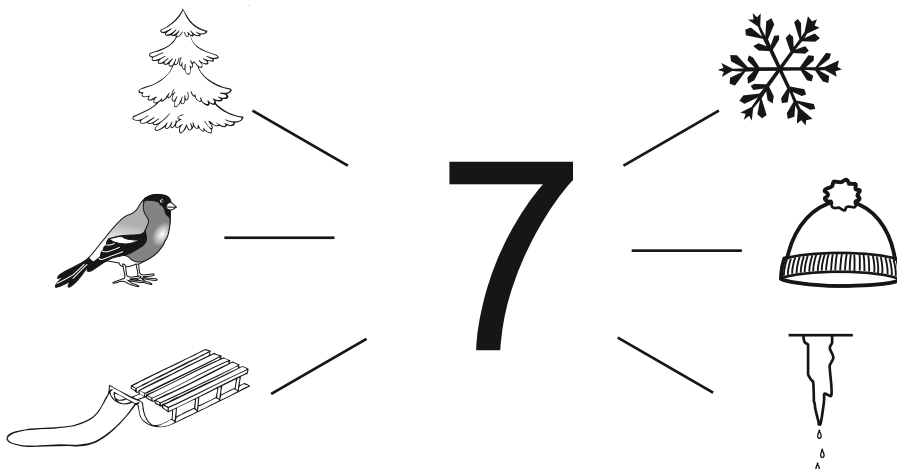
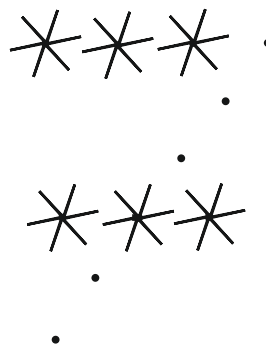
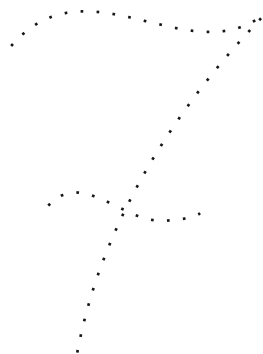
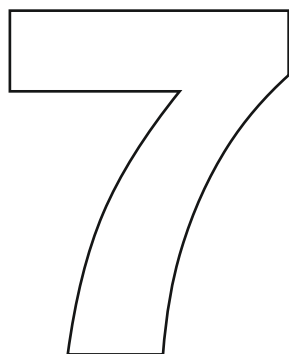

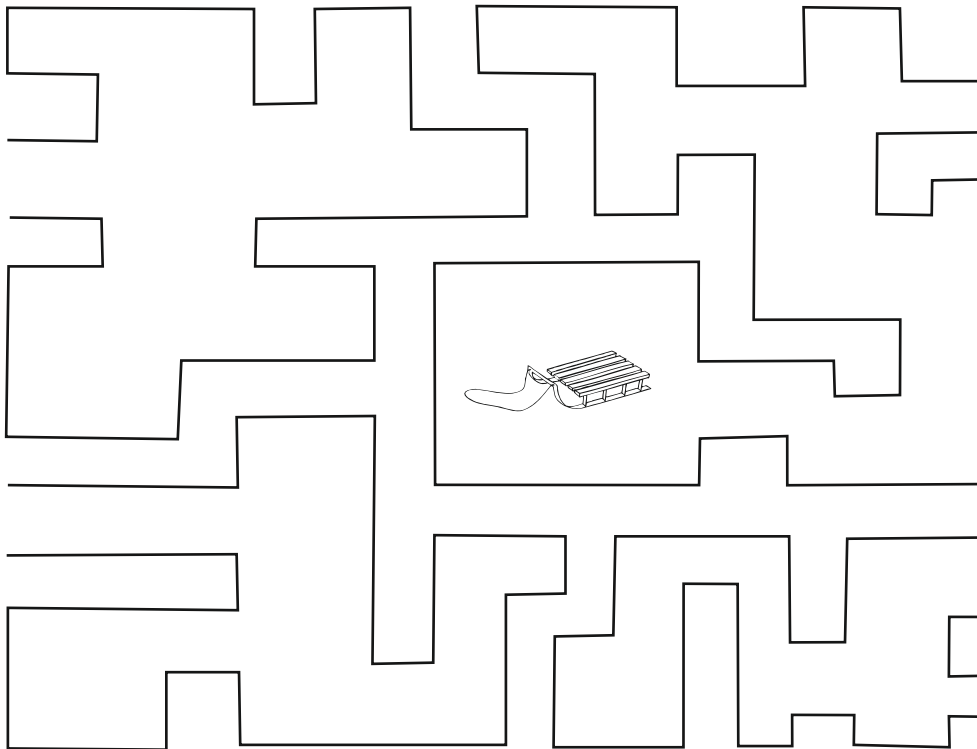
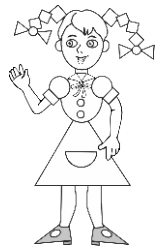
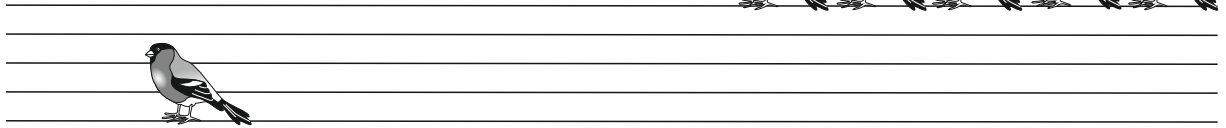

ЗАНЯТКИ 25

ЗАНЯТИЕ 25

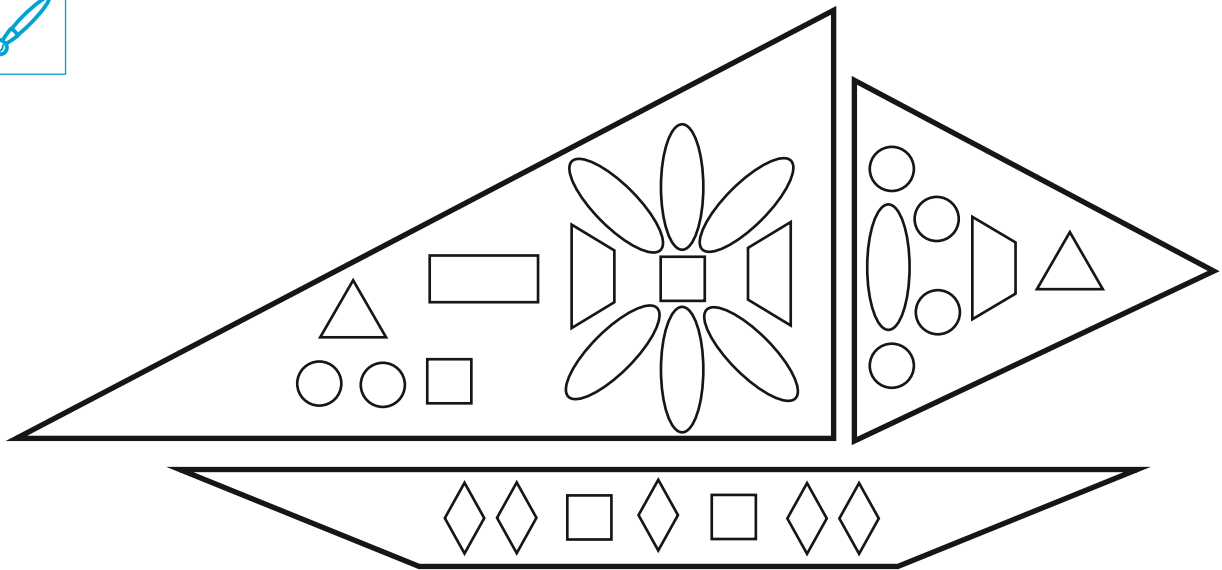
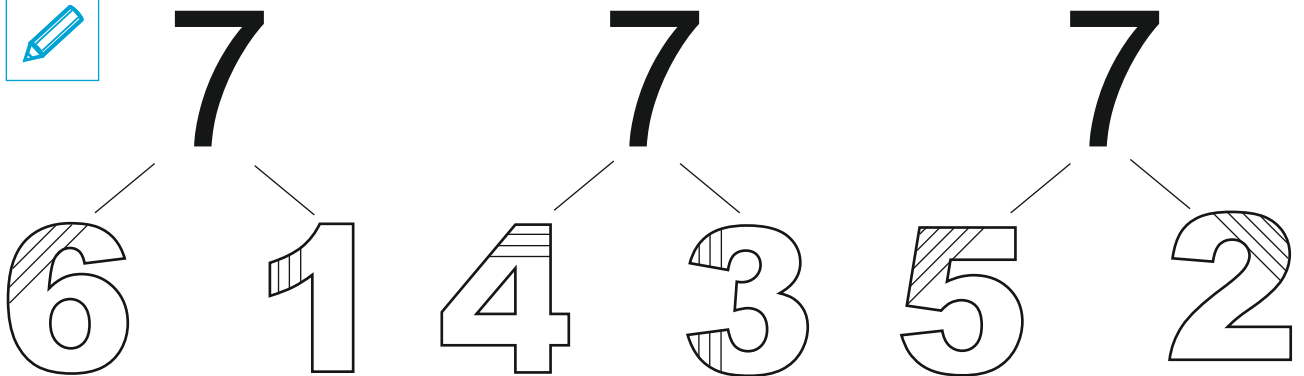



$4 - 2 =$

$3 + 1 =$

$6 - 1 =$

- 1
- 2
- 3
- 4
- 5
- 6
- 7



○	○					
△	△	△				
□						
◇	◇	◇				
🌲	🌲	🌲	🌲			
🚤	🚤	🚤	🚤	🚤	🚤	
🍊	🍊	🍊	🍊	🍊		

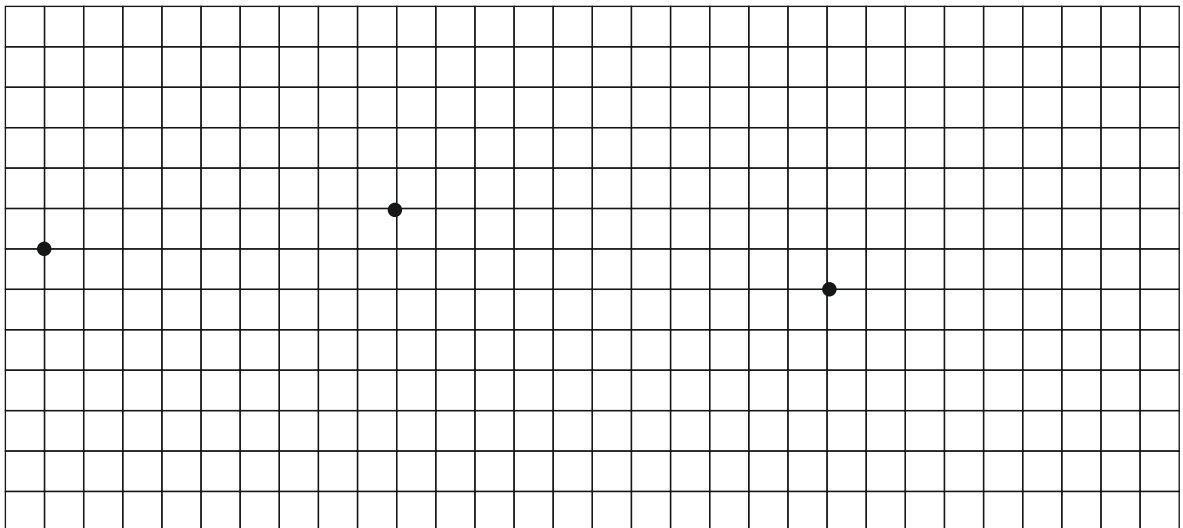

ЗАНЯТКИ 26

ЗАНЯТИЕ 26

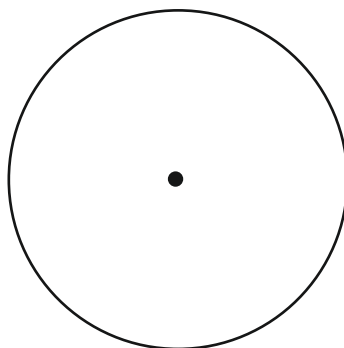
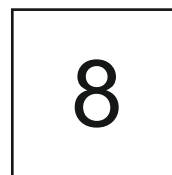
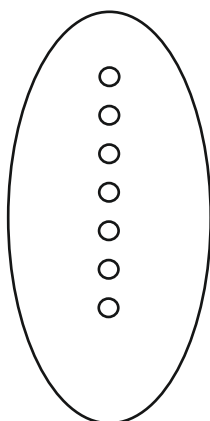
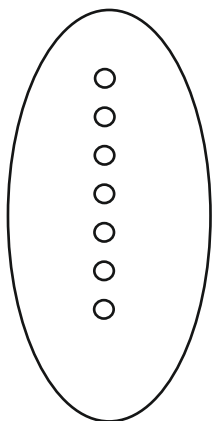

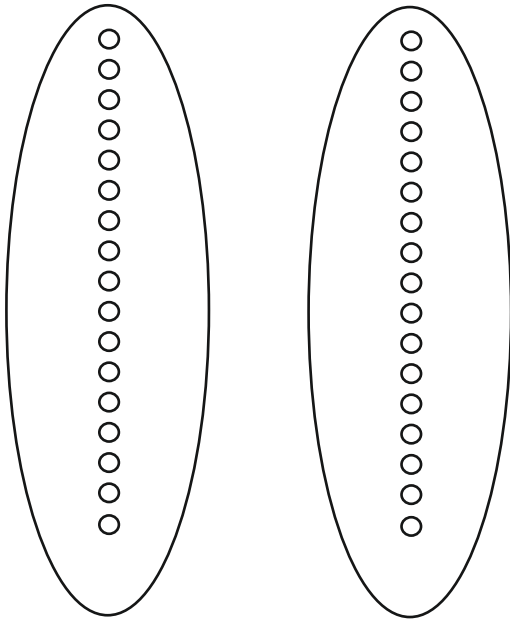

17

18

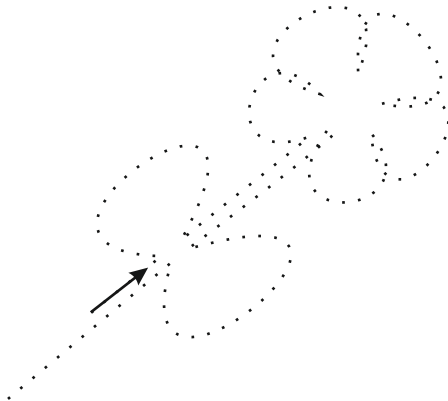
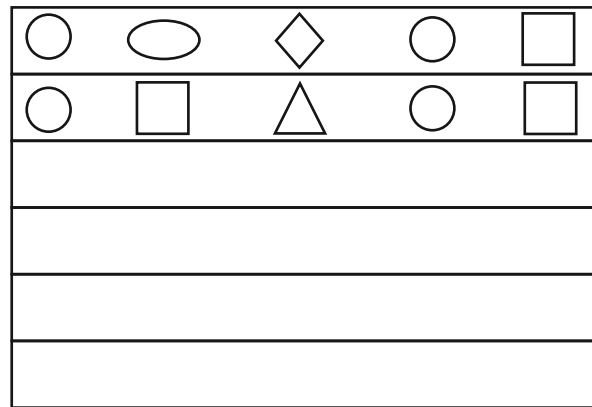
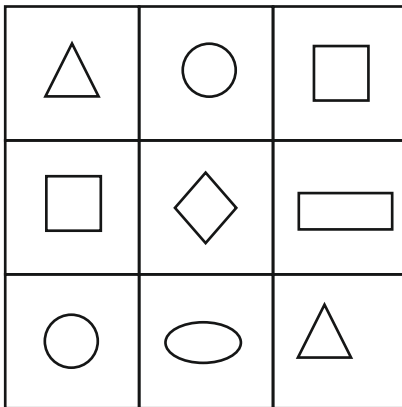

ЗАНЯТКИ 27

ЗАНЯТИЕ 27

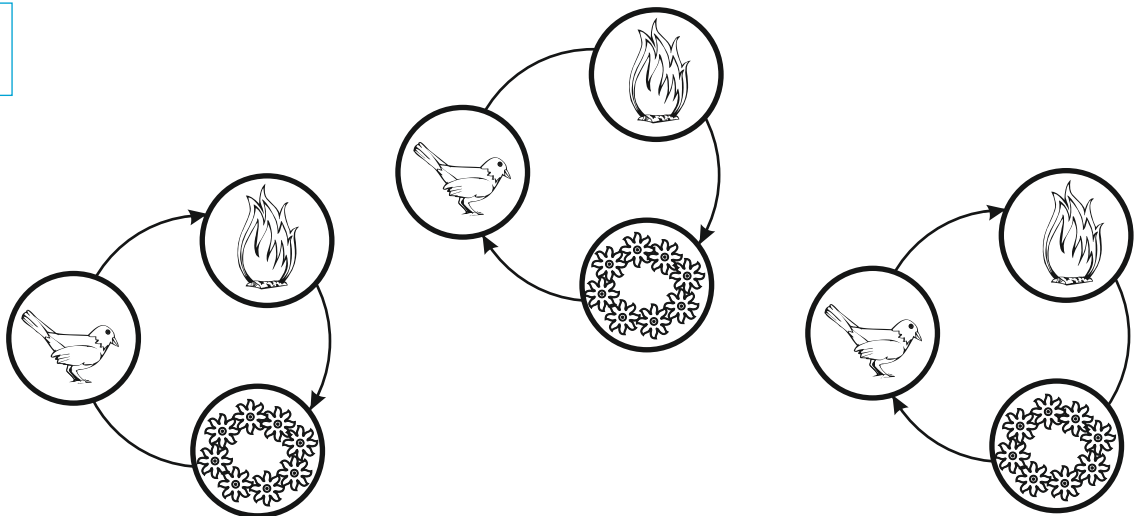
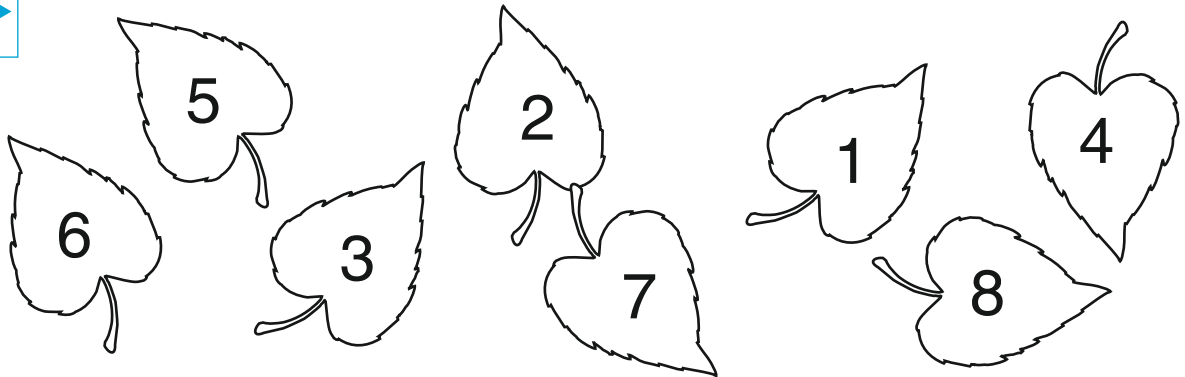
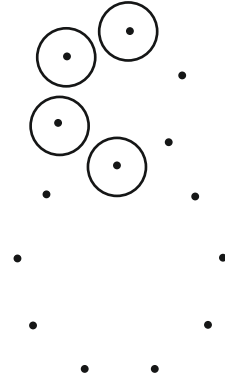
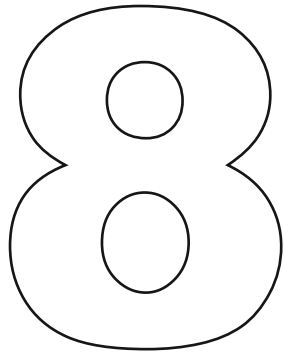

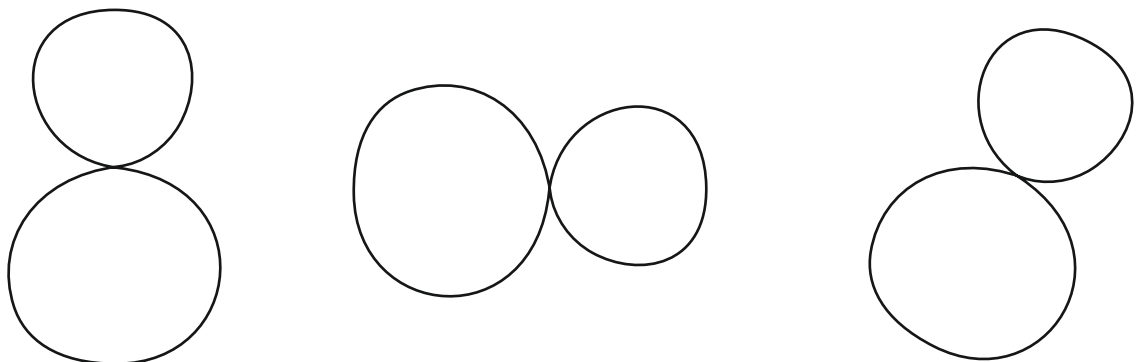
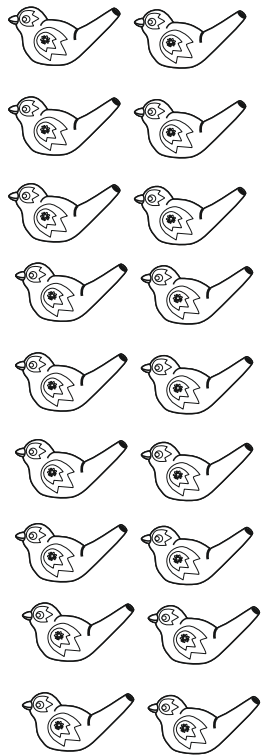
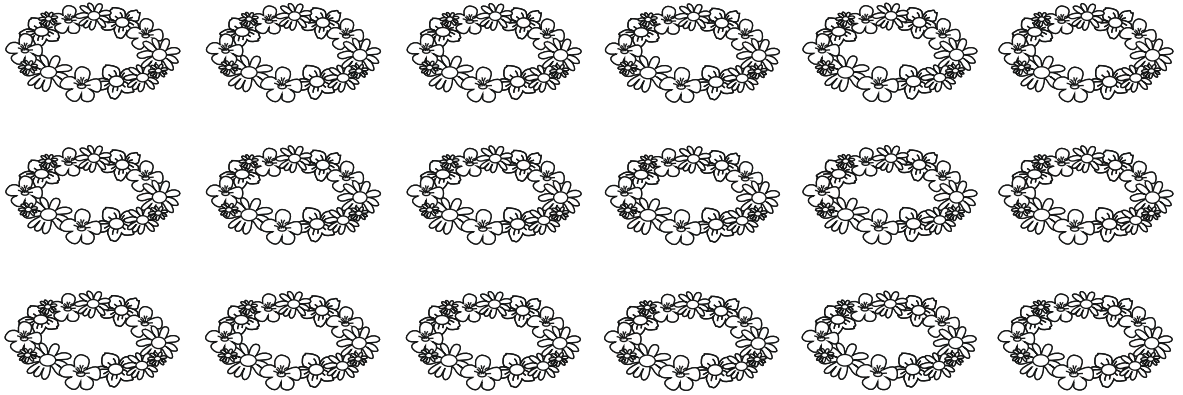

ЗАНЯТКИ 28

ЗАНЯТИЕ 28

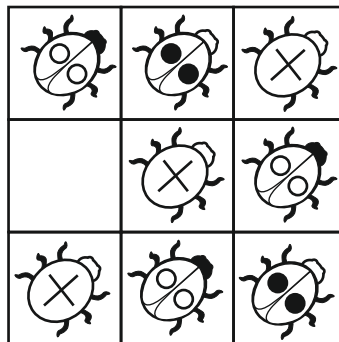
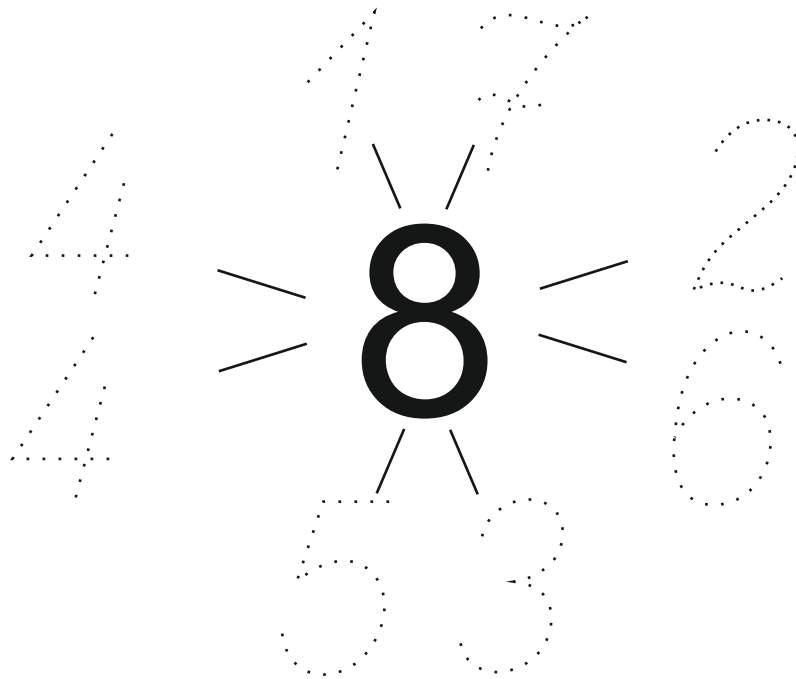
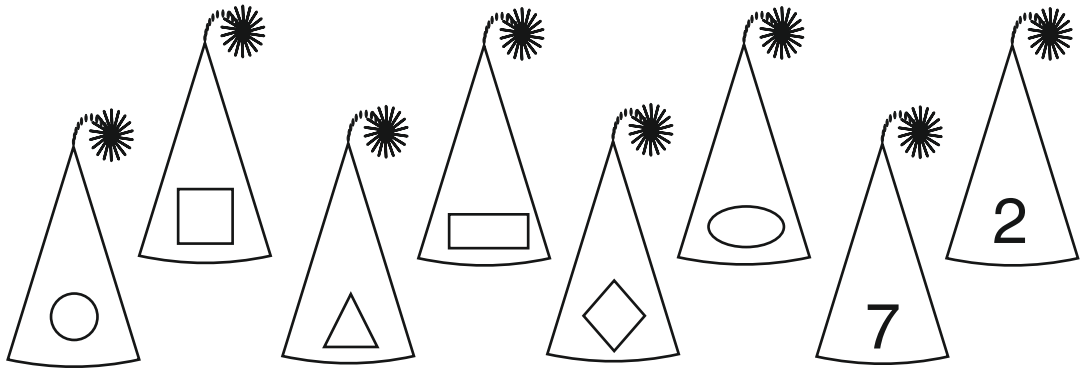

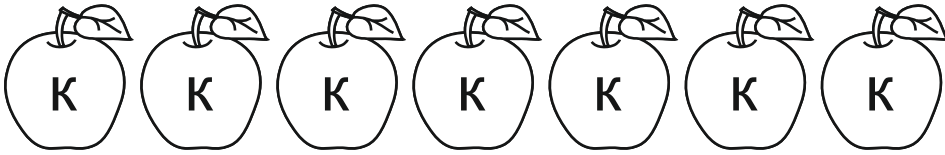

6		
3		
5		
4		
8		

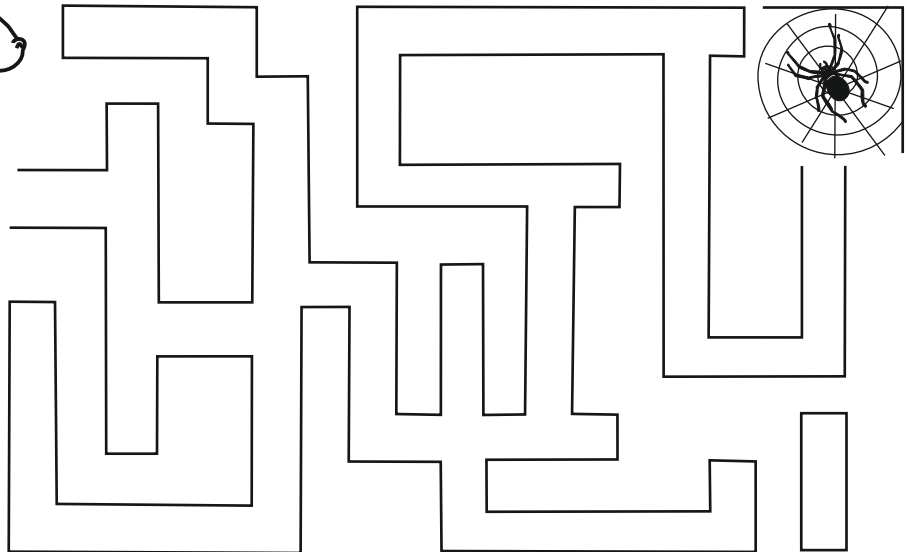
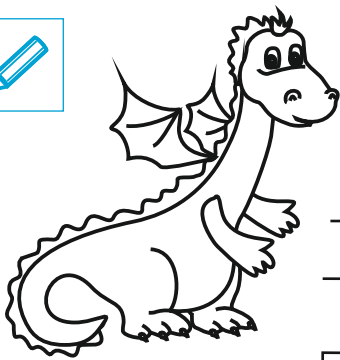

ЗАНЯТКІ 29

ЗАНЯТИЕ 29

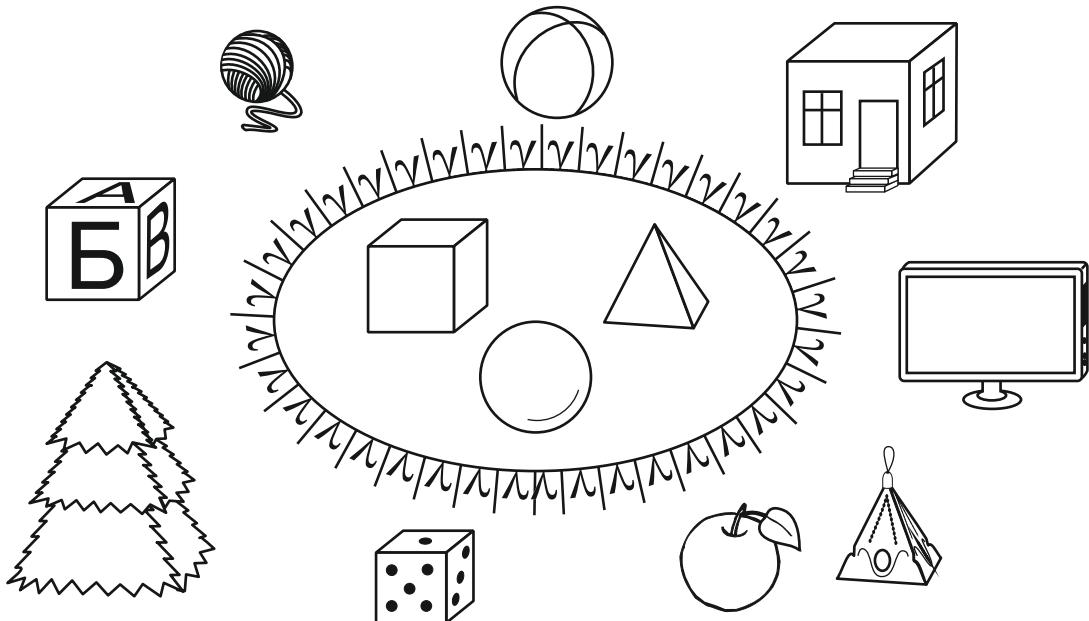
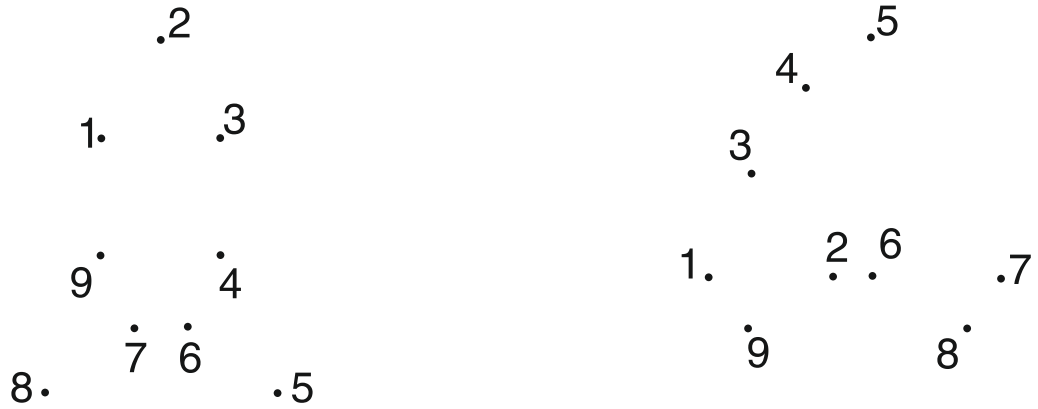
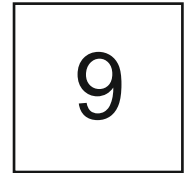
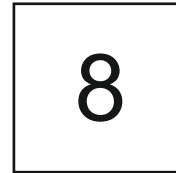
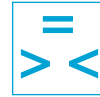
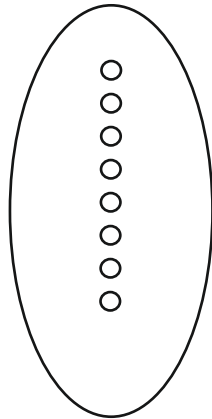
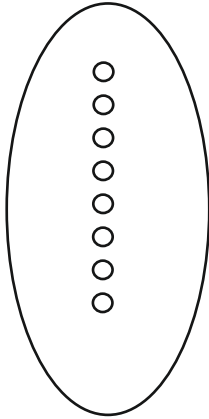

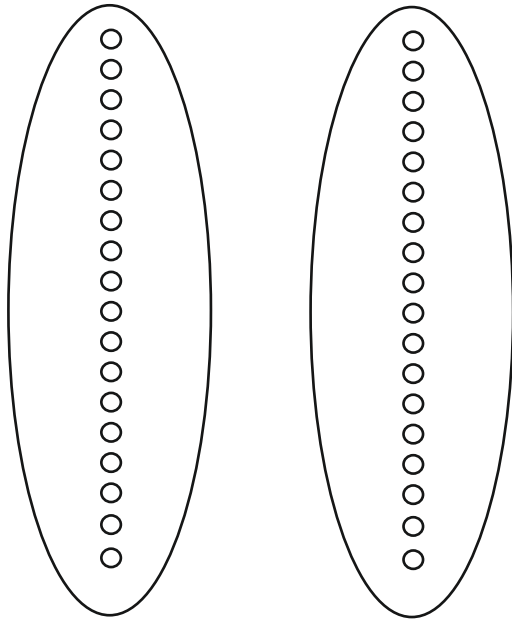

18

19

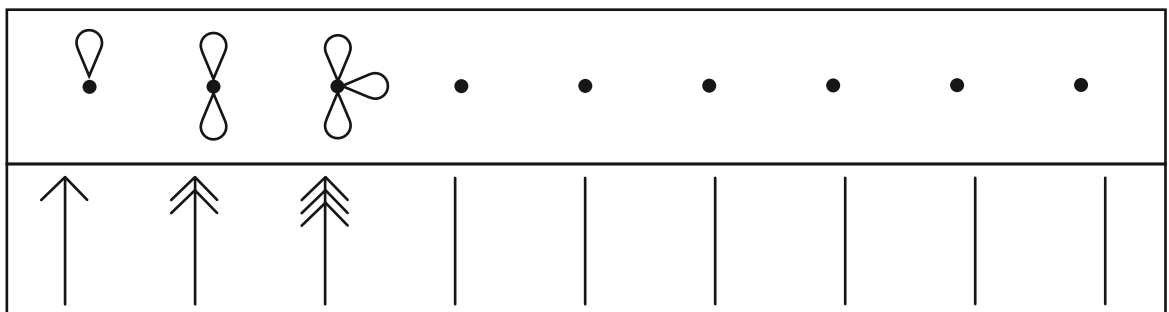
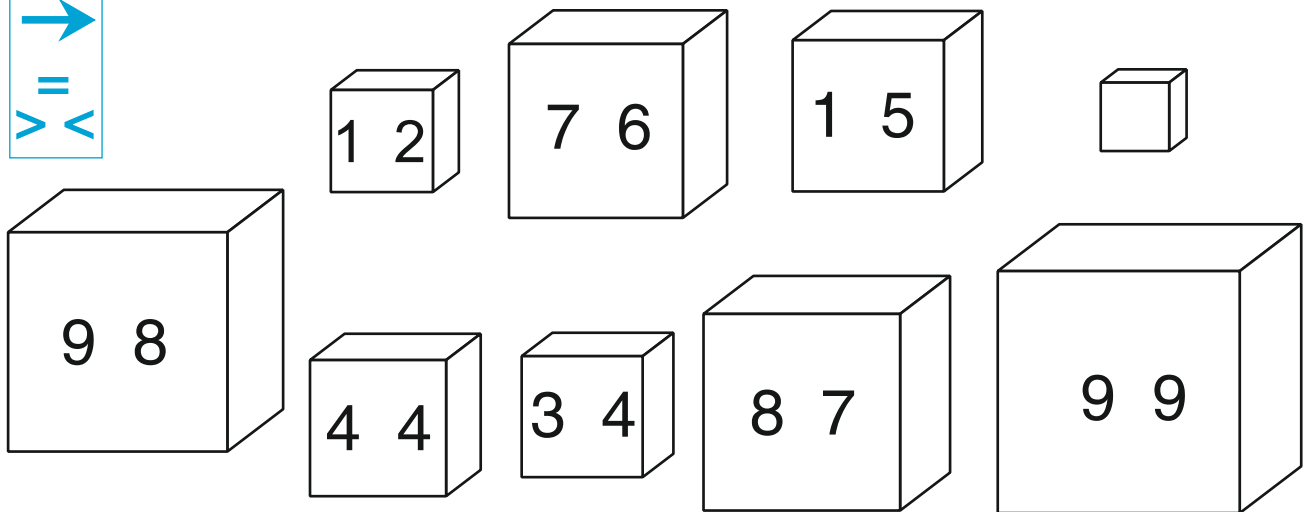

ЗАНЯТКІ 30

ЗАНЯТТІЕ 30

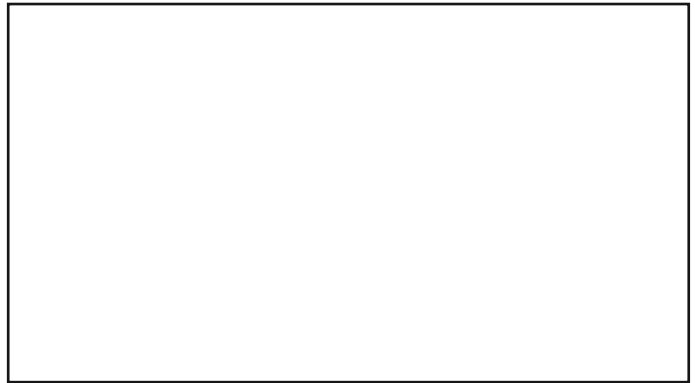
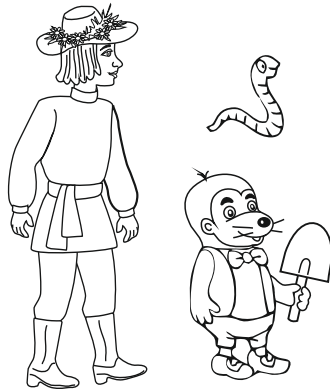
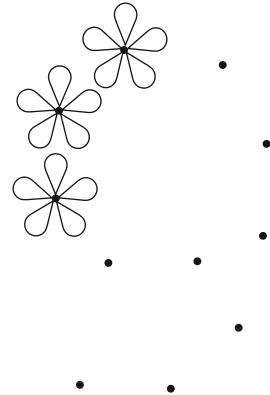
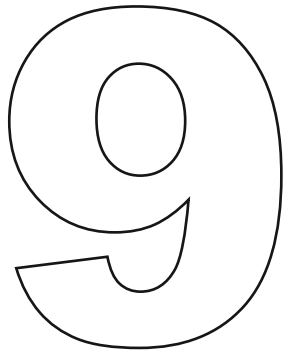

- | | | | | | | | | |
|---|---|---|---|---|---|---|---|---|
| 1 | 2 | 3 | 4 | 5 | 6 | 7 | 8 | 9 |
|---|---|---|---|---|---|---|---|---|

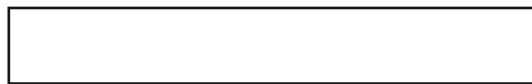
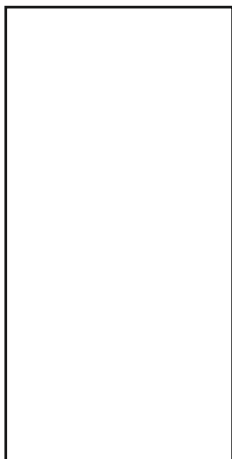

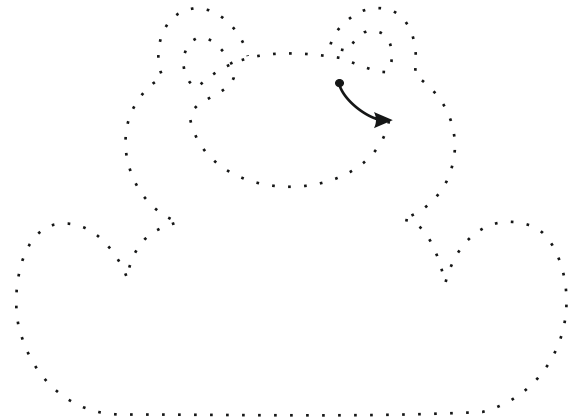
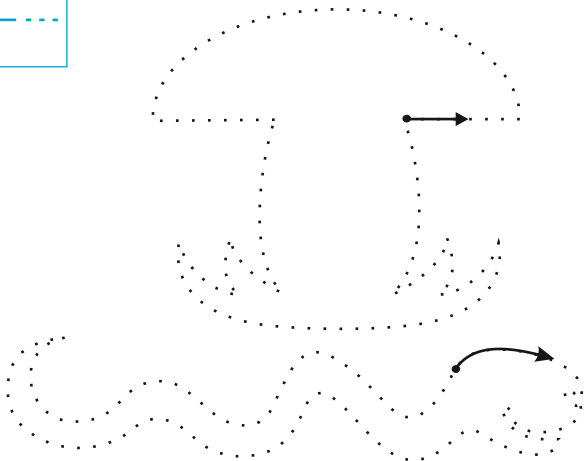
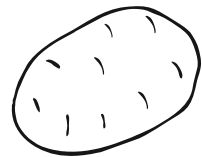
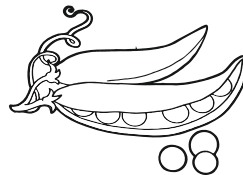
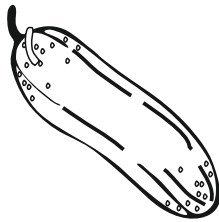
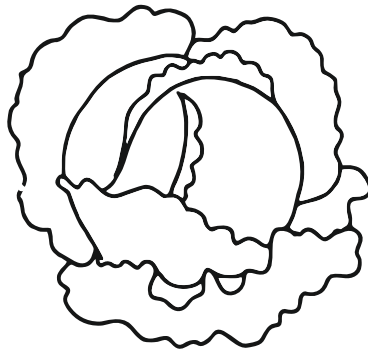
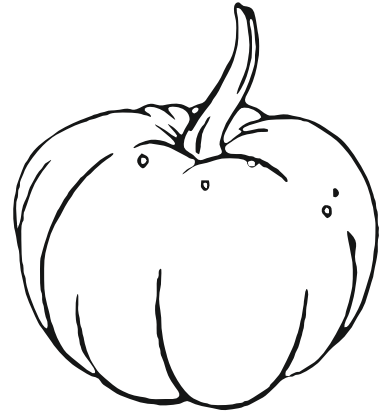
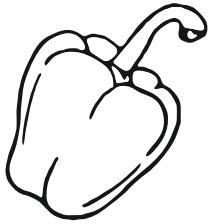
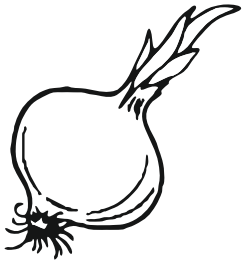

ЗАНЯТКИ 31

ЗАНЯТИЕ 31

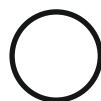
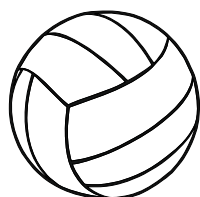
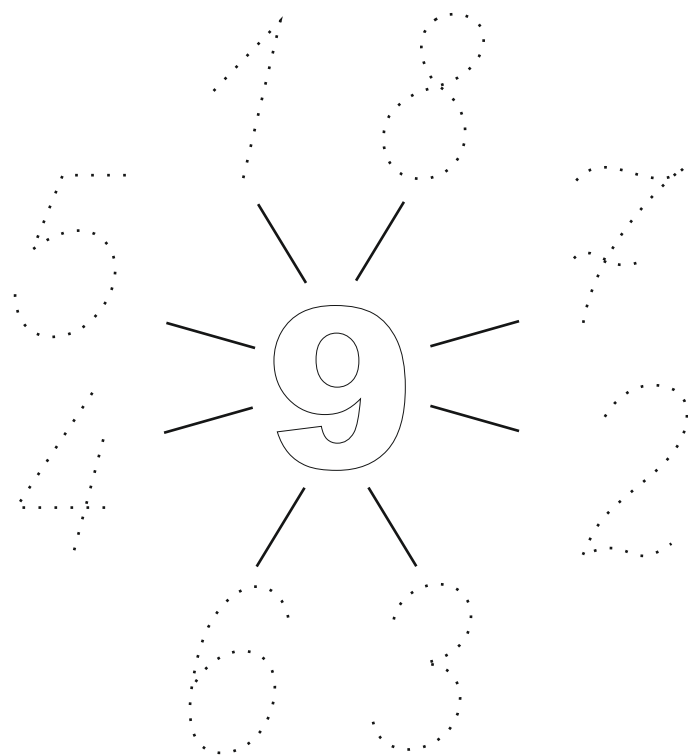

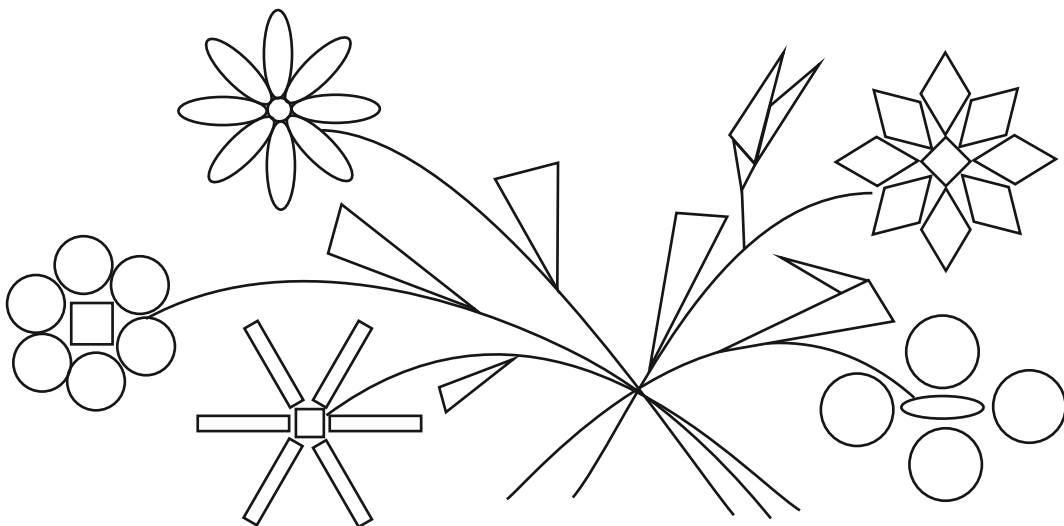
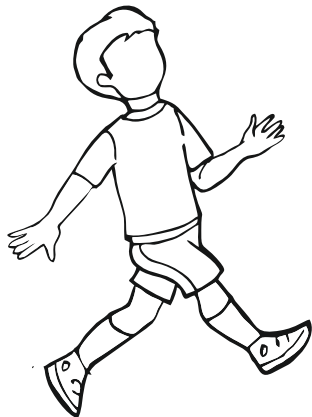

ЗАНЯТКИ 32

ЗАНЯТИЕ 32

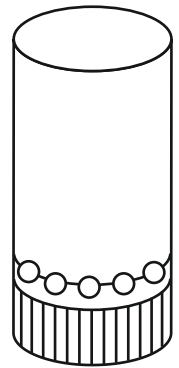
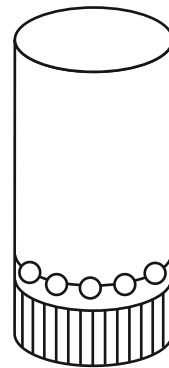
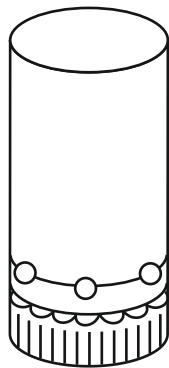
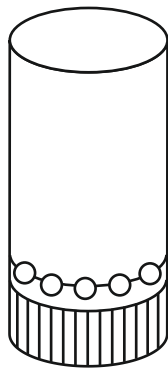
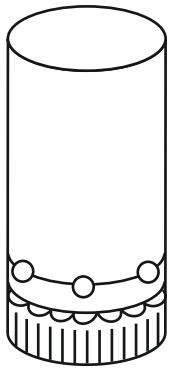
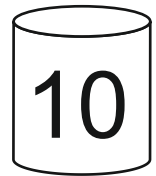
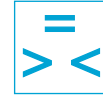
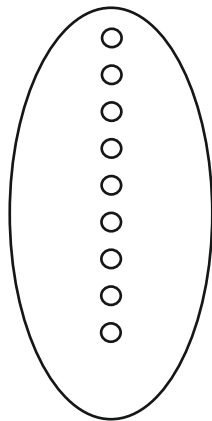
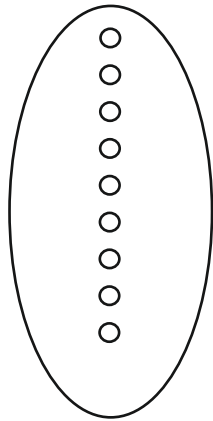

1	
3	
5	
2	
6	
4	

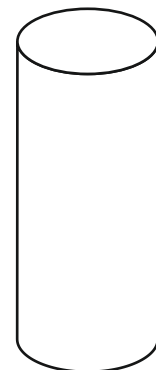
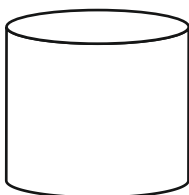
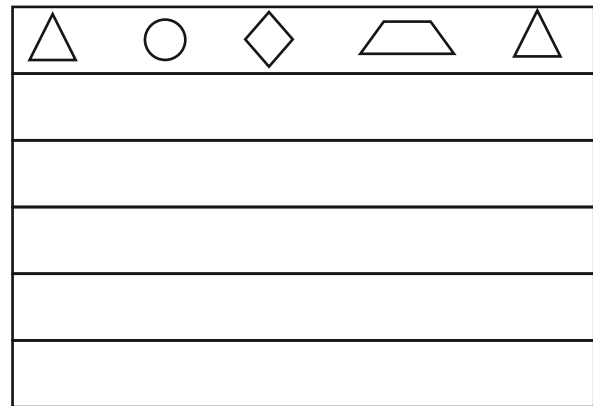
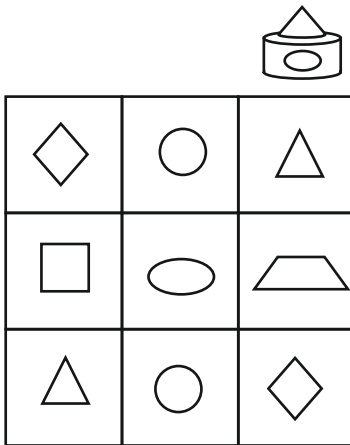
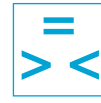
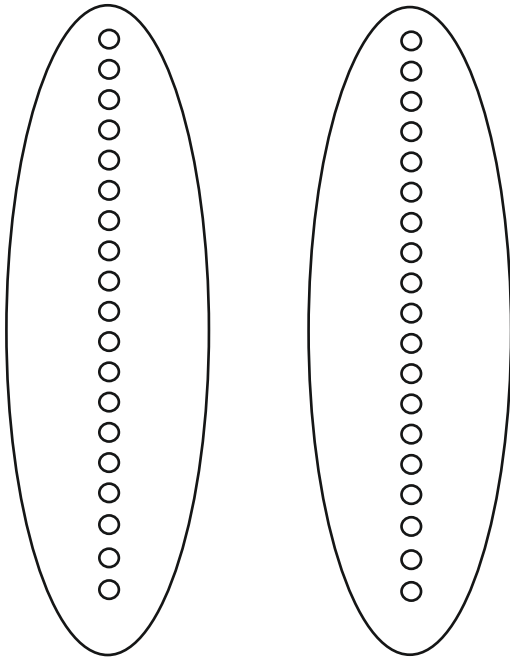

ЗАНЯТКИ 33

ЗАНЯТИЕ 33

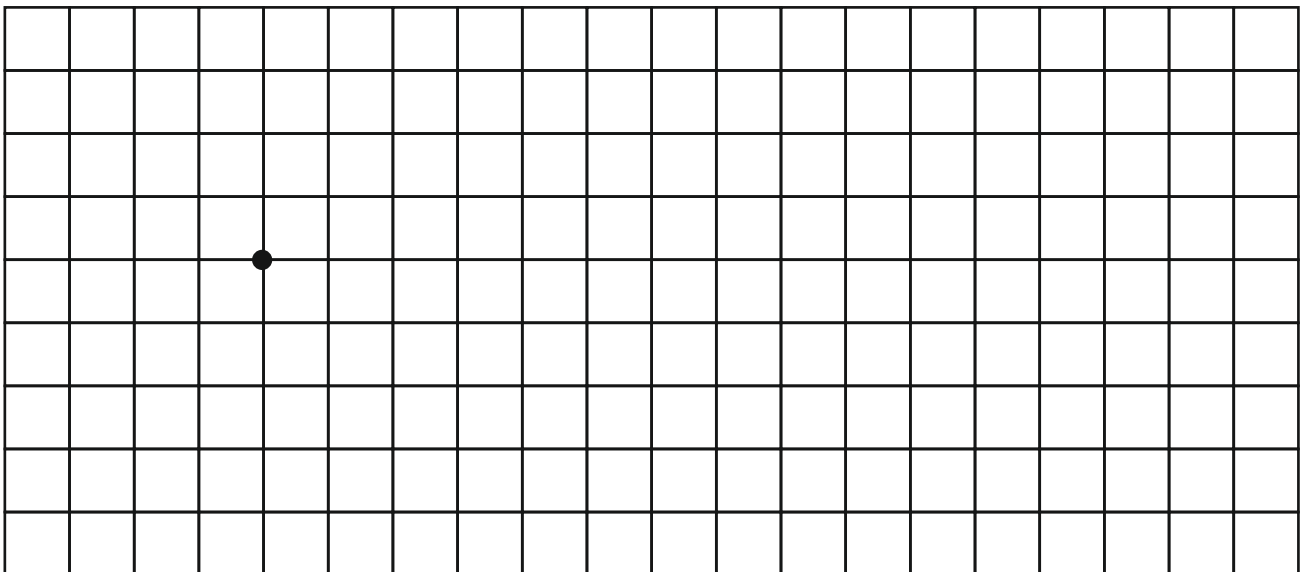
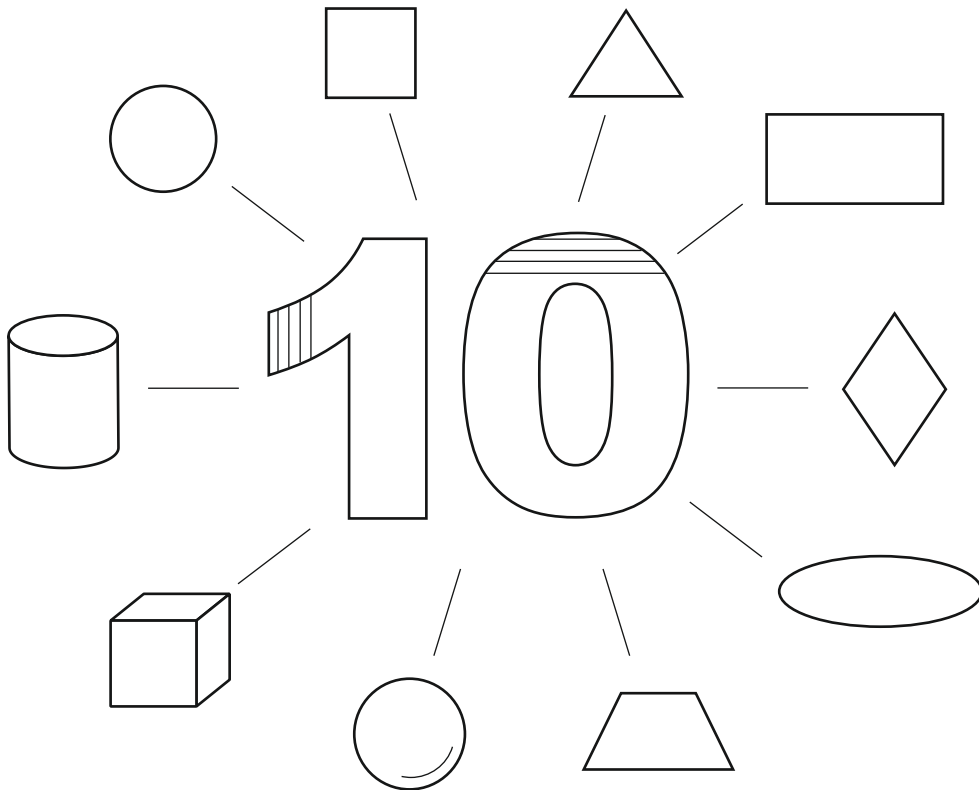

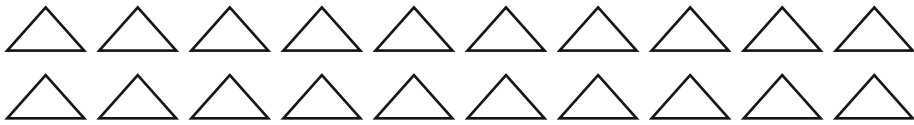
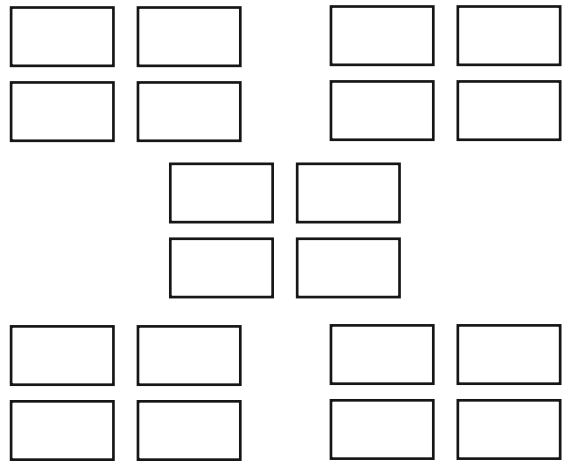
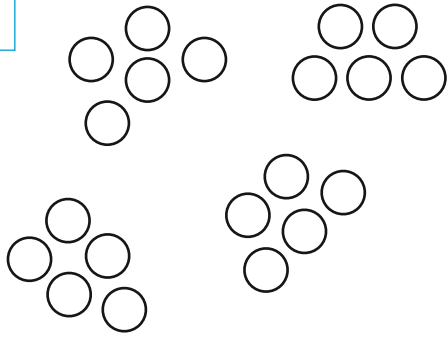

1				6
2				7
3				8
4				9
5				10

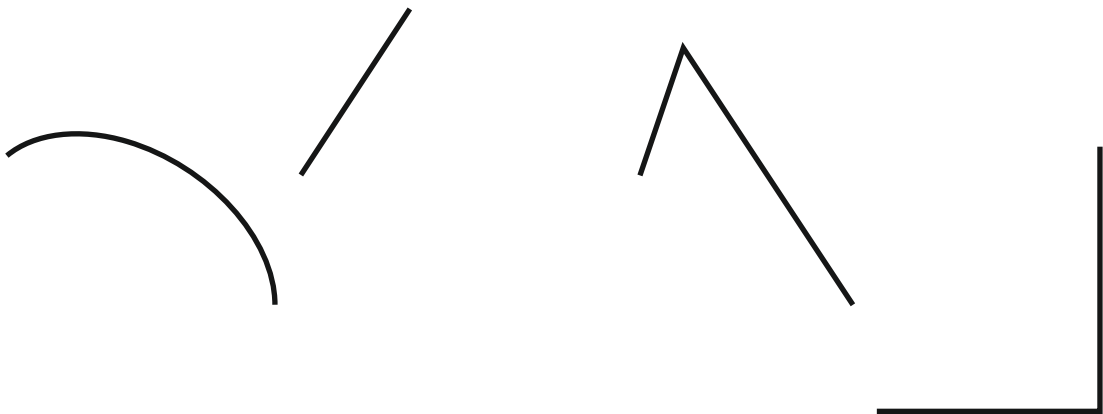

ЗАНЯТКІ 34

ЗАНЯТИЕ 34

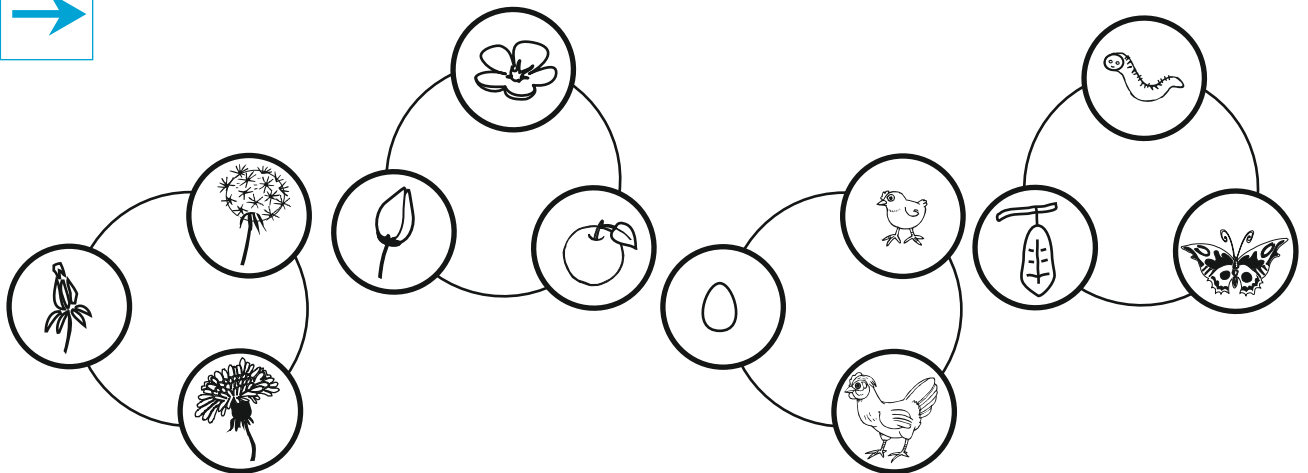
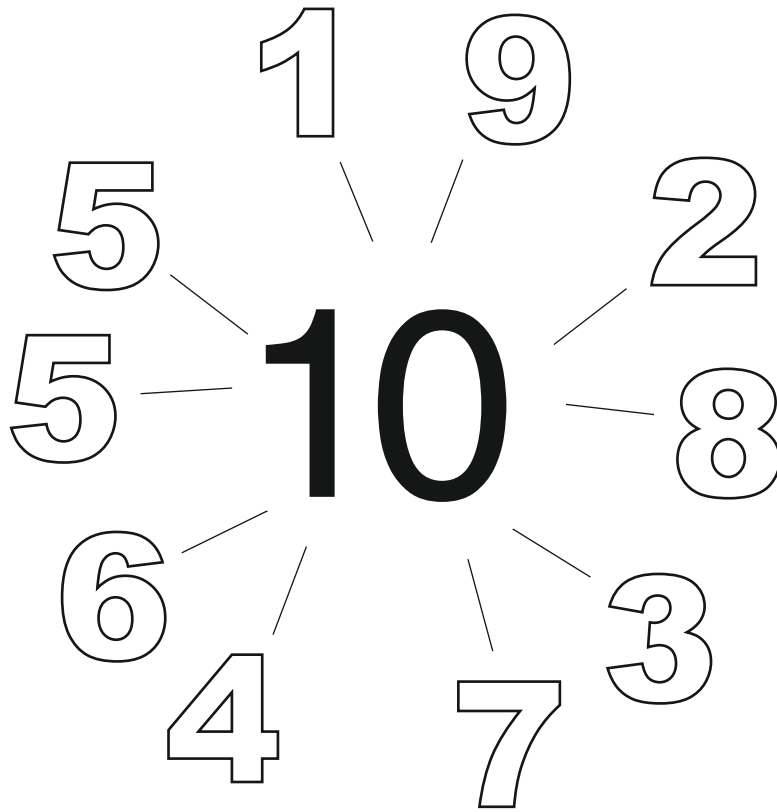

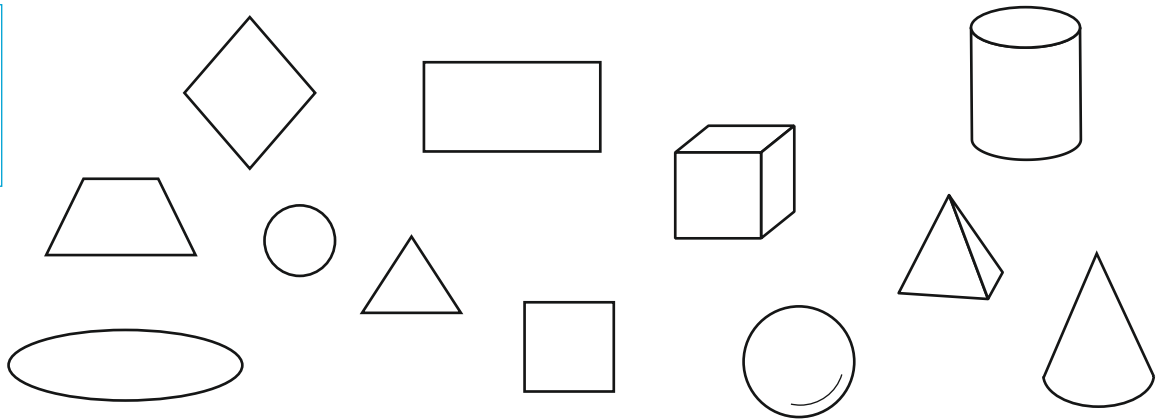

	10	
1		6
2		7
3		8
4		9
5		5

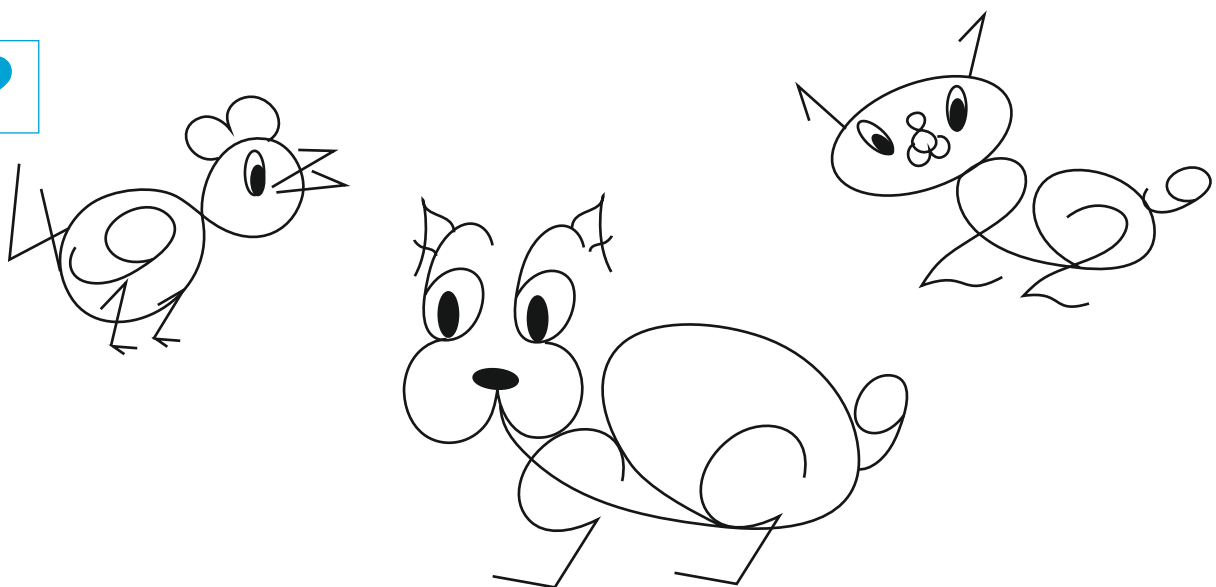

ЗАНЯТКИ 35

ЗАНЯТИЕ 35

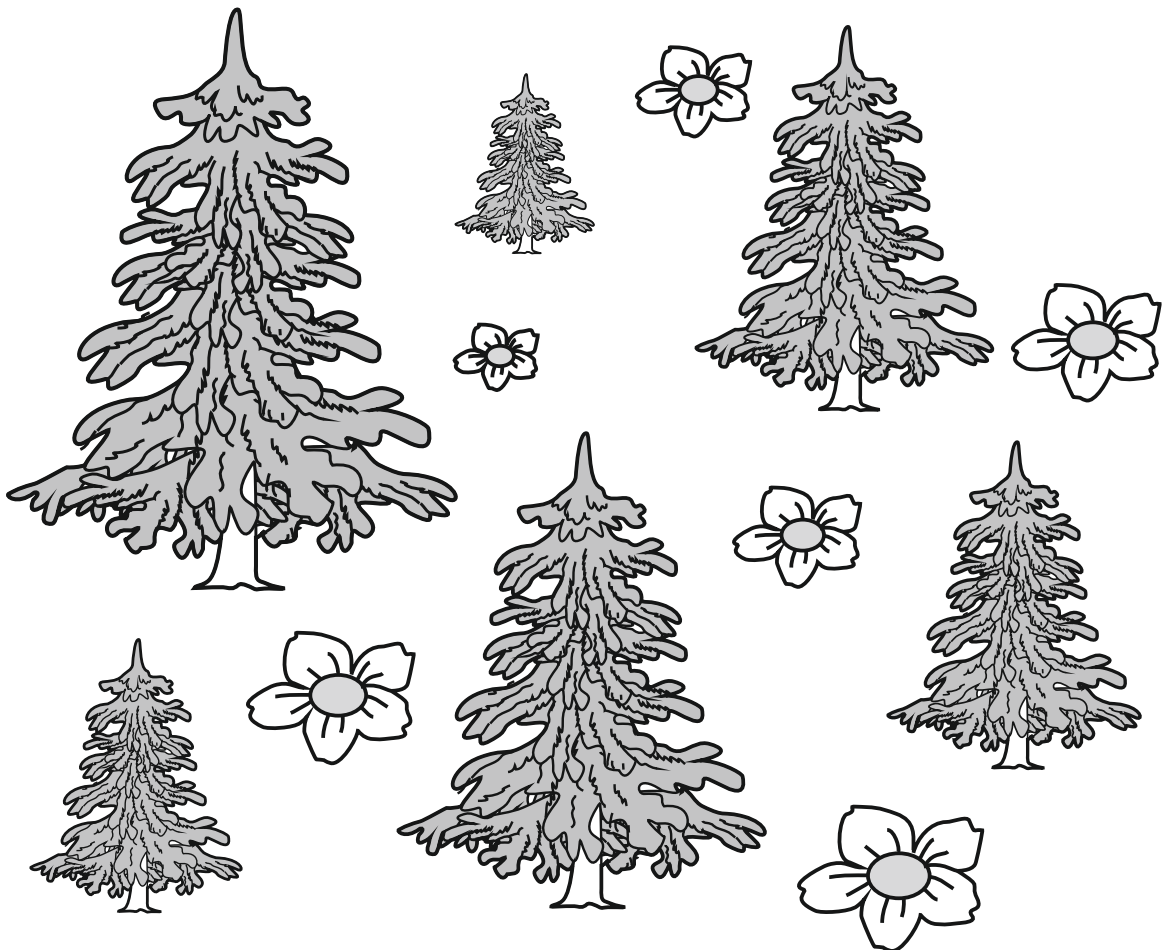
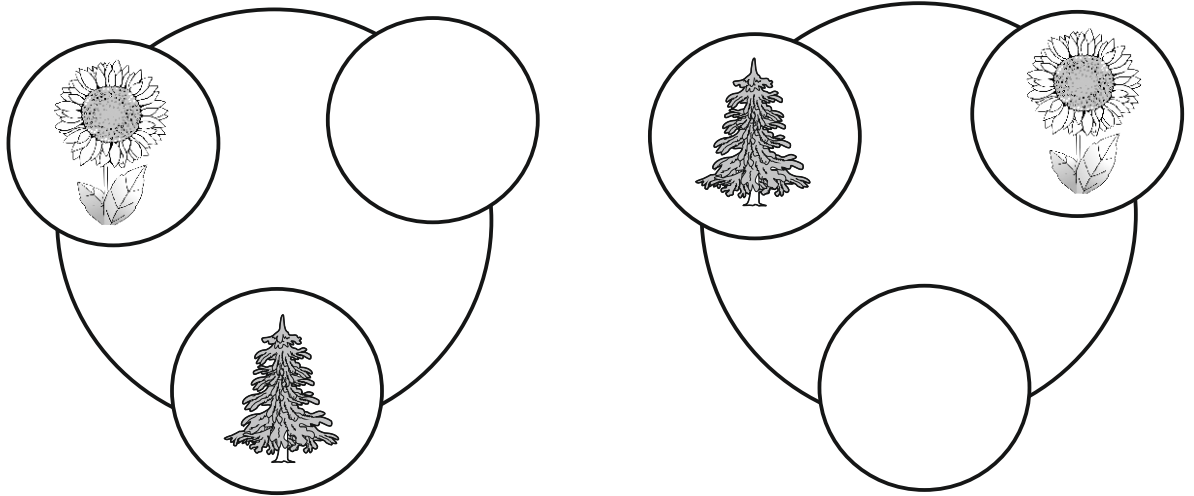

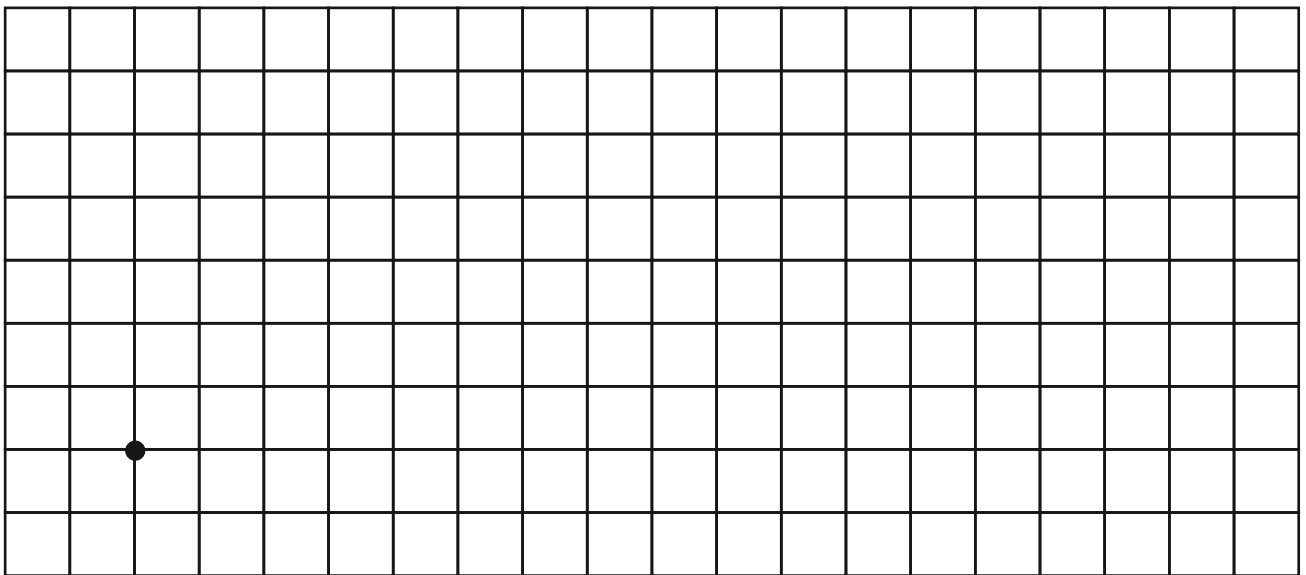
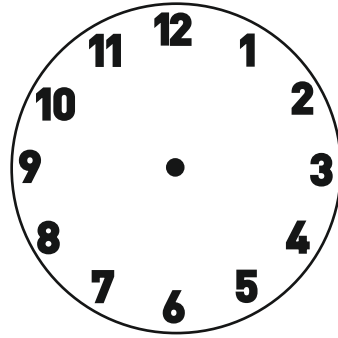
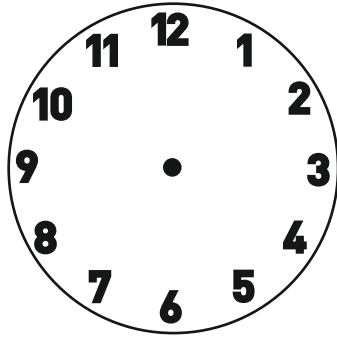
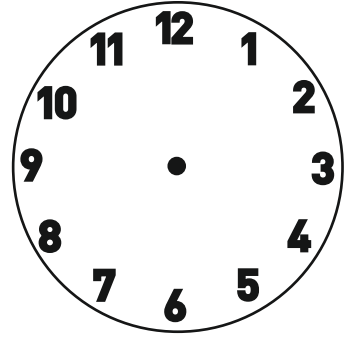
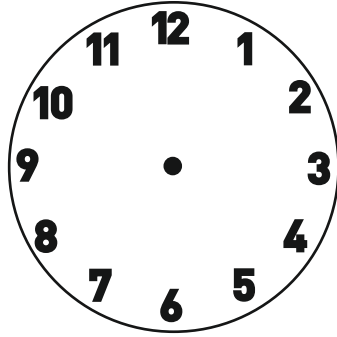
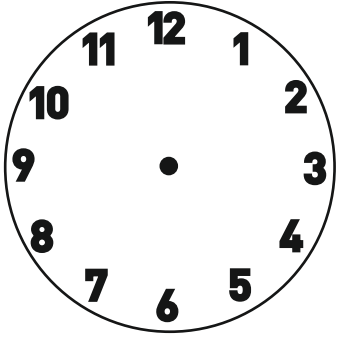

ЗАНЯТКИ 36

ЗАНЯТИЕ 36



9 10	7 6	1 2	3 3
	8 7	2 2	
4 5			8 9

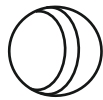

○	□	△	◌
▭	◇	○	▤
□	△	◌	▭
◇	○	□	△

◇	○	□	△	▭	▤	◌



1	1		3		4		4		6	6
2										7
3		5		7		9		6		8
4										9
5		8		6		8		9		10



Вучэбнае выданне
Жытко Ірына Уладзіміраўна
МАТЭМАТЫЧНЫ КАЛЕЙДАСКОП
РАБОЧЫ СШЫТАК

На беларускай і рускай мовах

Вучэбны дапаможнік для выхаванцаў старшых груп
(ад 5 да 7 гадоў) устаноў дашкольнай адукацыі
з беларускай і рускай мовамі навучання

Нач. рэдакцыйна-выдавецкага аддзела *Г. І. Бандарэнка*
Рэдактар *Т. У. Прымачонак*
Вокладка мастака *Н. А. Хромавай*
Мастакі *Н. А. Хромава, І. У. Шутко*
Мастацкі рэдактар *А. П. Пратасеня*
Камп'ютарная вёрстка *І. У. Шутко*
Карэктар *Д. Р. Лосік*

Падпісана да друку 14.01.2020. Фармат 84×108/16. Папера афсетная.
Друк афсетны. Ум. друк. арк. 7,98. Ул.-выд. арк. 8,0.
Тыраж 126 922 экз. Заказ

Навукова-метадычная ўстанова «Нацыянальны інстытут адукацыі»
Міністэрства адукацыі Рэспублікі Беларусь. Пасведчанне аб дзяржаўнай рэгістрацыі
выдаўца, вытворцы, распаўсюджвальніка друкаваных выданняў
№ 1/263 ад 02.04.2014. Вул. Караля, 16, 220004, г. Мінск

Таварыства з дадатковай адказнасцю «Дзівімакс».
Ліцэнзія на права ажыццяўлення паліграфічнай дзейнасці
№ 02330/53 ад 14.02.2014. Вул. Аэрадромная, 125, 220007, г. Мінск